

# Splicer blocks



## Catalog symbols:

- 160\_\_-(poles)
- 162\_\_-(poles)
- 163\_\_-(poles)
- 165\_\_-(poles)

## Description:

Bussmann™ series splicer blocks allow for increasing or decreasing wire size within a circuit to accommodate different connections from the power source to the branch load.

Splicer blocks are available for wire sizes up to 500 kcmil and amp ratings up to 760 A.

They are UL® Recognized to UL 1059 and rated for use in UL 508A industrial control panels.

These blocks are factory configured from 1- to 4-poles (catalog number dependent) with optional covers available to enhance safety (order covers separately).

## Catalog number example:

**16204-3 is a 3-pole 16204**

Where:

- The prefix “16204” defines the block’s lineside and loadside characteristics (i.e., conductor port per pole that accepts 2/0 - #14 Cu, or 2/0 - #12 Al conductors).
- The suffix “3” in this example defines this as a three-pole block.
- See the catalog number tables for details on the available lineside/loadside characteristics.

## How to order:

From the catalog number tables, select the catalog number that defines the desired lineside/loadside port and conductor characteristics.

Add to the catalog number the suffix that defines the desired pole configuration. Note, you must select from the available number of poles for each catalog number. These appear in the second column of the catalog number tables.

## Specifications:

### Ratings

- Volts: 600 V
- Amps: 115 to 760 A
- SCCR: up to 200 kA\* (see table for SCCR by catalog number)
- \* Maximum SCCR contingent upon the application of an upstream current-limiting overcurrent protective device. See table for fusing requirements.

### Flammability rating

- UL 94 V0

### Storage and operating temperature range

- -4°F to 248°F (-20°C to 120°C)

### Agency information

- UL 1059 Recognized, Guide XCFR2, File E62622
- CSA® Certified, Class 6228-01, File 15364

### Conductors†

- Stranded 75°C copper and aluminum
- Higher temperature rated conductors permitted with appropriate derating

† As specified in the catalog number table.







### Optional covers

- See table for catalog numbers specific to each block

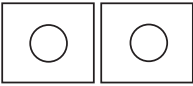
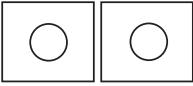
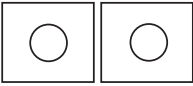

Powering Business Worldwide

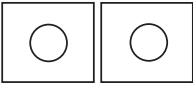
**Catalog numbers:**

Line/load port configuration	No. of poles	Current rating (A)	Lineside				Loadside					
			Wire size (Str/ferrule unless noted)*	Wires per port	Torque N•m (Lb-in)	Ports/Pole	Wire size (Str/ferrule unless noted)*	Wires per port	Torque N•m (Lb-in)	Ports/pole	SCCR (kA)	Catalog number
	1, 2, 3	115	#2 - #3 Cu/Al (Str) #4 - #6 Cu/Al (Str) #8 Cu/Al (Str) #10 - #14 Cu (Str)	1 1 1 1	5.6 (50) 5.1 (45) 4.5 (40) 4.0 (35)	1	#2 - #3 Cu/Al (Str) #4 - #6 Cu/Al (Str) #8 Cu/Al (Str) #10 - #14 Cu (Str)	1 1 1 1	5.6 (50) 5.1 (45) 4.5 (40) 4.0 (35)	1	10	16200- **
	1, 2, 3	150	1/0 - #3 Cu (Str) #4 - #6 Cu (Str) #8 Cu (Str) #10 - #14 Cu (Str)	1 1 1 1	5.6 (50) 5.1 (45) 4.5 (40) 4.0 (35)	1	1/0 - #3 Cu (Str) #4 - #6 Cu (Str) #8 Cu (Str) #10 - #14 Cu (Str)	1 1 1 1	5.6 (50) 5.1 (45) 4.5 (40) 4.0 (35)	1	10	16201-
	2, 3, 4	175	2/0 - #1 Cu/Al (Str) #2 - #8 Cu/Al #10 - #12 Al (Str) #10 - #14 Cu	1 1 1 1	12.4 (110) 4.0 (35) 4.0 (35)	1	2/0 - #1 Cu/Al (Str) #2 - #8 Cu/Al #10 - #12 Al (Str) #10 - #14 Cu	1 1 1 1	12.4 (110) 4.0 (35) 4.0 (35)	1	10	16000- **
	1, 2, 3	175	#4 - #8 Cu/Al #10 - #14 Cu	2 2	13.6 (120) 13.6 (120)	1	#4 - #8 Cu/Al #10 - #14 Cu	2 2	13.6 (120) 13.6 (120)	1	200†	16204-
	2, 3, 4	255	250kcmil - #6 Cu	1	42.4 (375)	1	250kcmil - #6 Cu	1	42.4 (375)	1	10	16003- **
	1, 2, ,3	255	250kcmil - #6 Cu	1	42.4 (375)	1	250kcmil - #6 Cu	1	42.4 (375)	1	10	16301-
	2, 3, 4	310	350kcmil - 2/0 Cu/Al (Str) 1/0 Cu/Al (Str) #1 - #6 Cu/Al	1 1-2 1-2	31.1 (275)††	1	350kcmil - 2/0 Cu/Al (Str) 1/0 Cu/Al (Str) #1 - #6 Cu/Al	1 1-2 1-2	31.1 (275)††	1	10	16005- **
	1, 2, ,3	310	350kcmil - 2/0 Cu/Al (Str) 1/0 Cu/Al (Str) #1 - #6 Cu/Al	1 1-2 1-2	31.1 (275)††	1	350kcmil - 2/0 Cu/Al (Str) 1/0 Cu/Al (Str) #1 - #6 Cu/Al	1 1-2 1-2	31.1 (275)††	1	10	16303-
	1, 2, ,3	380	500kcmil - 4/0 Cu/Al (Str) 3/0 - 1/0 Cu/Al (Str) #1 - #6 Cu/Al	1 1-2 1-2	56.5 (500)	1	500kcmil - 4/0 Cu/Al (Str) 3/0 - 1/0 Cu/Al (Str) #1 - #6 Cu/Al	1 1-2 1-2	56.5 (500)	1	10	16306-
	1, 2, ,3	620	350kcmil - 2/0 Cu/Al (Str) 1/0 Cu/Al (Str) #1 - #4 Cu/Al #6 Cu/Al	1 1-2 1-2 2	31.1 (275)††	2	350kcmil - 2/0 Cu/Al (Str) 1/0 Cu/Al (Str) #1 - #4 Cu/Al #6 Cu/Al	1 1-2 1-2 2	31.1 (275)††	2	10	16500-
	1, 2, ,3	760	500kcmil - 4/0 Cu/Al (Str) 3/0 - 1/0 Cu/Al (Str) #1 - #6 Cu/Al	1 1-2 1-2	56.5 (500)	2	500kcmil - 4/0 Cu/Al (Str) 3/0 - 1/0 Cu/Al (Str) #1 - #6 Cu/Al	1 1-2 1-2	56.5 (500)	2	10	16504-

\* 75°C wire (higher temperature rated wire acceptable with appropriate derating). Using a ferrule on a stranded conductor requires a correctly sized UL Listed ferrule (customer supplied) applied according to the manufacturer's specifications. Ferrule ratings apply to copper wire only.

\*\* Not covered by CSA certification.

† See table below for the tested upstream overcurrent protective devices necessary for achieving this SCCR.

†† Torque rating for dual wire and ferrule application is 30.5 N•m (270 Lb-in).

**Short-Circuit Current Rating (SCCR) data for block 16204-:**

Catalog number	No. of poles	Conductors (AWG)		Fuse class/Bussmann series symbol/ampacity				SCCR	Minimum enclosure size
		Lineside	Loadside	J LPJ	RK1 LPN-RK (250 V), LPS-RK (600 V)	RK5 FRN-R (250 V), FRS-R (600 V)	T JJN (300 V), JJS (600 V)		
16204-	1, 2, 3	2/0 - #8	2/0 - #8	200	200	60	200	200 kA	16 x 16 x 6.75

**Dual wire port application**

- Rated for dual wire port application to increase the possible number of lineside and loadside connections. E.g., 16303-1 can accept two wires into the lineside port (1/0 - #6 Cu/Al) and two wires per port (2 connections per pole total) on the loadside lug (1/0 - #6 Cu/Al).
- Dual wire applications are only viable when using two wires of the same size, stranding, and insulating and conductor material in the same port.

**Ferrule terminal application**

- Busmann series splicer blocks are rated for use with UL Listed ferrules (see catalog number table for details). Ferrule ratings apply to copper wire only.
- Ferrule applications allow for the use of a broader range of conductor stranding and simulate a more efficient, solid wire connection with the PDB terminal port.
- Always use UL Listed ferrules in accordance with the manufacturer's specifications and instructions.

**Dimensions — in**

**160\_ blocks**

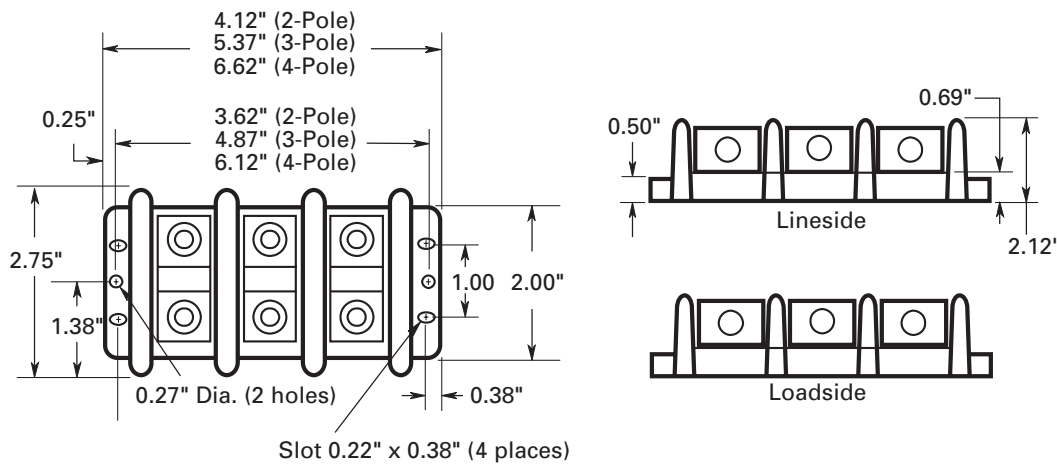

**162\_, 163\_ and 165\_ blocks**

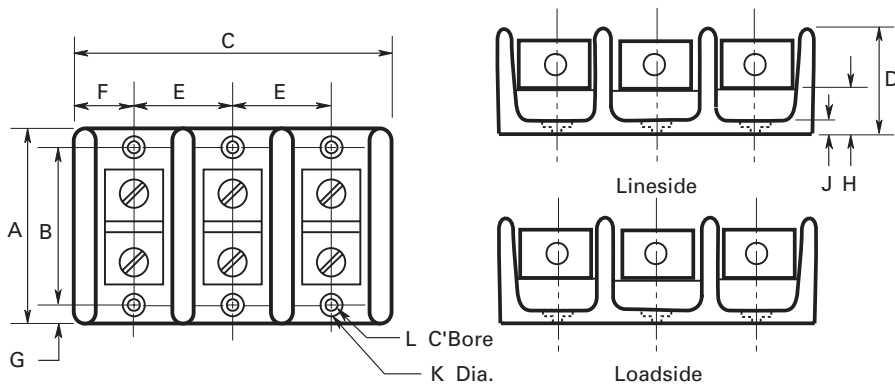

Catalog number prefix	A	B	C1	C2	C3	D	E	F	G	H	J	K	L
162_	2.88	2.25	1.07	1.88	2.70	1.75	0.82	0.54	0.32	0.84	0.31	0.20	0.41
163_	4.0	3.38	1.98	3.60	5.21	3.32	1.62	0.99	0.31	0.88	0.35	Slot 0.20" wide x 0.41" long	Slot 0.42" wide x 0.62" long
165_	5.5	4.75	3.11	5.76	8.48	2.94	2.69	1.55	0.36	1.19	0.44	Slot 0.20" wide x 0.33" long	Slot 0.41" wide x 0.53" long

**Optional covers**

Electrical safety can be enhanced by installing optional covers.

From the table below, order the cover catalog number that matches the block catalog number.

Block catalog number	Poles	Cover catalog number
16000-2	2	CPB160-2*
16000-3	3	CPB160-3*
16000-4	4	CPB160-4*
16003-2	2	CPB160-2*
16003-3	3	CPB160-3*
16003-4	4	CPB160-4*
16005-2	2	CPB160-2*
16005-3	3	CPB160-3*
16005-4	4	CPB160-4*
16200-1	1	CPB162-1*
16200-2	2	CPB162-2*
16200-3	3	CPB162-3*
16201-1	1	CPB162-1*
16201-2	2	CPB162-2*
16201-3	3	CPB162-3*
16204-1	1	CPB162-1*
16204-2	2	CPB162-2*
16204-3	3	CPB162-3*
16301-1	1	CPDB-1*
16301-2	2	CPDB-2*
16301-3	3	CPDB-3*
16303-1	1	CPDB-1*
16303-2	2	CPDB-2*
16303-3	3	CPDB-3*
16306-1	1	CPDB-1*
16306-2	2	CPDB-2*
16306-3	3	CPDB-3*
16500-1	1	CPDB165**
16500-2	2	CPDB165**
16500-3	3	CPDB165**
16504-1	1	CPDB165**
16504-2	2	CPDB165**
16504-3	3	CPDB165**

\* Cover catalog number provides one individual cover for each block.

\*\* Order one cover for each pole.

The only controlled copy of this data sheet is the electronic read-only version located on the Eaton network drive. All other copies of this document are by definition uncontrolled. This bulletin is intended to clearly present comprehensive product data and provide technical information that will help the end user with design applications. Eaton reserves the right, without notice, to change design or construction of any products and to discontinue or limit distribution of any products. Eaton also reserves the right to change or update, without notice, any technical information contained in this bulletin. Once a product has been selected, it should be tested by the user in all possible applications.

**Eaton**  
 1000 Eaton Boulevard  
 Cleveland, OH 44122  
 Eaton.com

Bussmann Division  
 114 Old State Road  
 Ellisville, MO 63021  
 United States  
 Eaton.com/bussmannseries

© 2017 Eaton  
 All Rights Reserved  
 Printed in USA  
 Publication No. 10534 — BU-MC16057  
 September 2017

Eaton and Bussmann are valuable trademarks of Eaton in the U.S. and other countries. You are not permitted to use the Eaton trademarks without prior written consent of Eaton.

CSA is a registered trademark of the Canadian Standards Group.  
 UL is a registered trademark of the Underwriters Laboratories, Inc.

For Eaton’s Bussmann series product information, call **1-855-287-7626** or visit: **Eaton.com/bussmannseries**

Follow us on social media to get the latest product and support information.

