

E3FA/E3RA/E3FB/E3RB

A new generation in sensing performance

- Simplicity
 - Simple selection
 - Simple installation
- One family for all
 - All standard applications covered
 - A wide variety of models
 - Models designed for special applications
- Non-stop detection
 - High quality and reliability
 - High EMC protection
 - High light immunity
 - Robust and waterproof housing



CE

 Refer to *Safety Precautions* on page 15.

For the most recent information on models that have been certified for safety standards, refer to your OMRON website.

Features

Simplicity

Omron's compact E3FA series of photoelectric sensors is simple and quick to mount, as well as easy and intuitive to set-up. The large and robust adjuster makes life much easier for installers to adjust the sensor, as does the bright, high-power red LED, which is clearly visible for easy alignment, even over longer distances. Similarly, the sensor's LED status indicator can be viewed from long distances and wide angles.



Compact size and shape. Can be installed almost anywhere.



Visible LED light for easy alignment.



Bright LED indicators for the easy operational status checking.

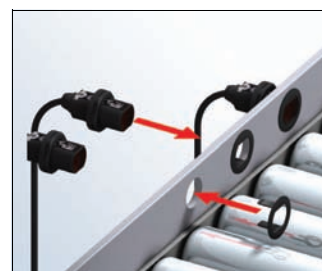

Flush mounting option for smooth installation.

One family for all

Typically installed in industrial plants ranging from food and beverage, textiles, ceramics and brick production, through to logistics, there's always an E3FA model to fit your application.

This extensive photoelectric sensor series with high reliability and enhanced performance includes through-beam, retroreflective and diffuse-reflective types in straight and radial versions. Straight versions are also available with background-suppression, limited-reflective detection, and transparent object detection types for special applications.

Application specific models



Limited-reflective types suitable for detecting transparent film to shiny, mirror film.

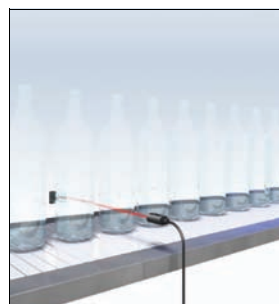

Transparent object detection types utilising Omron's unique technology for detecting objects with birefringent (double refraction) properties.

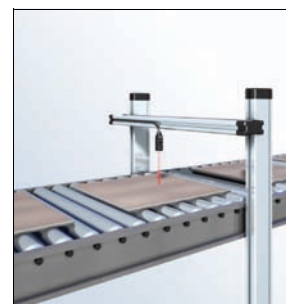

Background suppression types for the stable detection of different objects with various colours.

Non-stop detection

Especially designed for machines that never stop, the rugged E3FA series offers completely reliable sensing in a robust and waterproof housing that can withstand even high-pressure cleaning. Exceeding market standards, this series also has high EMC protection and light immunity. In addition, there is the added benefit of the high-power LED, which contributes to high sensing stability even in environments with dust or vibrations.





















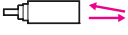

E3FA/E3RA/E3FB/E3RB

Ordering Information

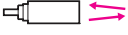

Sensors (E3FA Plastic housing) [Refer to *Dimensions on page 16.*]

 Red light  Infrared light

Sensor type	Sensing distance	Connection method	Model	
			NPN output	PNP output
Through-beam *1. 	 20 m	pre-wired	set E3FA-TN11 2M Emitter E3FA-TN11-L 2M Receiver E3FA-TN11-D 2M	set E3FA-TP11 2M Emitter E3FA-TP11-L 2M Receiver E3FA-TP11-D 2M
		M12 connector	set E3FA-TN21 Emitter E3FA-TN21-L Receiver E3FA-TN21-D	set E3FA-TP21 Emitter E3FA-TP21-L Receiver E3FA-TP21-D
	 15 m	pre-wired	set E3FA-TN12 2M Emitter E3FA-TN12-L 2M Receiver E3FA-TN12-D 2M	set E3FA-TP12 2M Emitter E3FA-TP12-L 2M Receiver E3FA-TP12-D 2M
		M12 connector	set E3FA-TN22 Emitter E3FA-TN22-L Receiver E3FA-TN22-D	set E3FA-TP22 Emitter E3FA-TP22-L Receiver E3FA-TP22-D
Retro-reflective with MSR function *2. 	 0.1 to 4 m with E39-R1S	pre-wired	E3FA-RN11 2M	E3FA-RP11 2M
		M12 connector	E3FA-RN21	E3FA-RP21
Coaxial Retro-reflective with MSR function *2. 	 0 to 500 mm with E39-R1S	pre-wired	E3FA-RN12 2M	E3FA-RP12 2M
		M12 connector	E3FA-RN22	E3FA-RP22
Diffuse-reflective 	 100 mm	pre-wired	E3FA-DN11 2M	E3FA-DP11 2M
		M12 connector	E3FA-DN21	E3FA-DP21
	 300 mm	pre-wired	E3FA-DN12 2M	E3FA-DP12 2M
		M12 connector	E3FA-DN22	E3FA-DP22
	 1 m	pre-wired	E3FA-DN13 2M	E3FA-DP13 2M
		M12 connector	E3FA-DN23	E3FA-DP23
	 100 mm	pre-wired	E3FA-DN14 2M	E3FA-DP14 2M
		M12 connector	E3FA-DN24	E3FA-DP24
	 300 mm	pre-wired	E3FA-DN15 2M	E3FA-DP15 2M
		M12 connector	E3FA-DN25	E3FA-DP25
	 1 m	pre-wired	E3FA-DN16 2M	E3FA-DP16 2M
		M12 connector	E3FA-DN26	E3FA-DP26
BGS (background suppression) 	 100 mm	pre-wired	E3FA-LN11 2M	E3FA-LP11 2M
		M12 connector	E3FA-LN21	E3FA-LP21
	 200 mm	pre-wired	E3FA-LN12 2M	E3FA-LP12 2M
		M12 connector	E3FA-LN22	E3FA-LP22
Limited distance reflective 	 10 to 50 mm	pre-wired	E3FA-VN11 2M	E3FA-VP11 2M
		M12 connector	E3FA-VN21	E3FA-VP21
Transparent detected with P-opaqing function *2. 	 100 to 500 mm with E39-RP1	pre-wired	E3FA-BN11 2M	E3FA-BP11 2M
		M12 connector	E3FA-BN21	E3FA-BP21
Transparent detected with P-opaqing function *2. 	 0.1 to 2 m with E39-RP1	pre-wired	E3FA-BN12 2M	E3FA-BP12 2M
		M12 connector	E3FA-BN22	E3FA-BP22







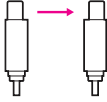

*1. The set type includes the emitter and receiver.

*2. The Reflector is sold separately. Select the Reflector model most suited to the application.

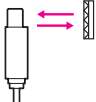

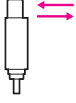
Sensors (E3RA Plastic housing) [Refer to Dimensions on page 16.]

 Red light

Sensor type	Sensing distance	Connection method	Model	
			NPN output	PNP output
Through-beam *1. 	 15 m	pre-wired	set E3RA-TN11 2M Emitter E3RA-TN11-L 2M Receiver E3RA-TN11-D 2M	set E3RA-TP11 2M Emitter E3RA-TP11-L 2M Receiver E3RA-TP11-D 2M
		M12 connector	set E3RA-TN21 Emitter E3RA-TN21-L Receiver E3RA-TN21-D	set E3RA-TP21 Emitter E3RA-TP21-L Receiver E3RA-TP21-D
Retro-reflective with MSR function *2. 	 0.1 to 3 m with E39-R1S	pre-wired	E3RA-RN11 2M	E3RA-RP11 2M
		M12 connector	E3RA-RN21	E3RA-RP21
Diffuse-reflective 	 100 mm	pre-wired	E3RA-DN11 2M	E3RA-DP11 2M
		M12 connector	E3RA-DN21	E3RA-DP21
	 300 mm	pre-wired	E3RA-DN12 2M	E3RA-DP12 2M
		M12 connector	E3RA-DN22	E3RA-DP22
	 700 mm	pre-wired	E3RA-DN13 2M	E3RA-DP13 2M
		M12 connector	E3RA-DN23	E3RA-DP23

*1. The set type includes the emitter and receiver.

















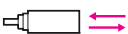







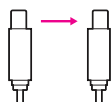

*2. The Reflector is sold separately. Select the Reflector model most suited to the application.

E3FA/E3RA/E3FB/E3RB

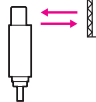

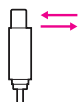
Sensors (E3FB/E3RB Metal housing) [Refer to Dimensions on page 17.]

 Red light



Sensor type	Sensing distance	Connection method	Model	
			NPN output	PNP output
Through-beam *1. 	 20 m	pre-wired	set E3FB-TN11 2M Emitter E3FB-TN11-L 2M Receiver E3FB-TN11-D 2M	set E3FB-TP11 2M Emitter E3FB-TP11-L 2M Receiver E3FB-TP11-D 2M
		M12 connector	set E3FB-TN21 Emitter E3FB-TN21-L Receiver E3FB-TN21-D	set E3FB-TP21 Emitter E3FB-TP21-L Receiver E3FB-TP21-D
Retro-reflective with MSR function *2. 	 0.1 to 4 m with E39-R1S	pre-wired	E3FB-RN11 2M	E3FB-RP11 2M
		M12 connector	E3FB-RN21	E3FB-RP21
Coaxial Retro-reflective with MSR function *2. 	 0 to 500 mm with E39-R1S	pre-wired	E3FB-RN12 2M	E3FB-RP12 2M
		M12 connector	E3FB-RN22	E3FB-RP22
Diffuse-reflective 	 100 mm	pre-wired	E3FB-DN11 2M	E3FB-DP11 2M
		M12 connector	E3FB-DN21	E3FB-DP21
	 300 mm	pre-wired	E3FB-DN12 2M	E3FB-DP12 2M
		M12 connector	E3FB-DN22	E3FB-DP22
	 1 m	pre-wired	E3FB-DN13 2M	E3FB-DP13 2M
		M12 connector	E3FB-DN23	E3FB-DP23
BGS (background suppression) 	 100 mm	pre-wired	E3FB-LN11 2M	E3FB-LP11 2M
		M12 connector	E3FB-LN21	E3FB-LP21
	 200 mm	pre-wired	E3FB-LN12 2M	E3FB-LP12 2M
		M12 connector	E3FB-LN22	E3FB-LP22
Limited distance reflective 	 10 to 50 mm	pre-wired	E3FB-VN11 2M	E3FB-VP11 2M
		M12 connector	E3FB-VN21	E3FB-VP21
Transparent detected with P-opaqing function *2. 	 100 to 500 mm with E39-RP1	pre-wired	E3FB-BN11 2M	E3FB-BP11 2M
		M12 connector	E3FB-BN21	E3FB-BP21
Transparent detected with P-opaqing function *2. 	 0.1 to 2 m with E39-RP1	pre-wired	E3FB-BN12 2M	E3FB-BP12 2M
		M12 connector	E3FB-BN22	E3FB-BP22
Through-beam *1. 	 15 m	pre-wired	set E3RB-TN11 2M Emitter E3RB-TN11-L 2M Receiver E3RB-TN11-D 2M	set E3RB-TP11 2M Emitter E3RB-TP11-L 2M Receiver E3RB-TP11-D 2M
		M12 connector	set E3RB-TN21 Emitter E3RB-TN21-L Receiver E3RB-TN21-D	set E3RB-TP21 Emitter E3RB-TP21-L Receiver E3RB-TP21-D
Retro-reflective with MSR function *2. 	 0.1 to 3 m with E39-R1S	pre-wired	E3RB-RN11 2M	E3RB-RP11 2M
		M12 connector	E3RB-RN21	E3RB-RP21
Diffuse-reflective 	 100 mm	pre-wired	E3RB-DN11 2M	E3RB-DP11 2M
		M12 connector	E3RB-DN21	E3RB-DP21
	 300 mm	pre-wired	E3RB-DN12 2M	E3RB-DP12 2M
		M12 connector	E3RB-DN22	E3RB-DP22
	 700 mm	pre-wired	E3RB-DN13 2M	E3RB-DP13 2M
		M12 connector	E3RB-DN23	E3RB-DP23

*1. The set type includes the emitter and receiver.

*2. The Reflector is sold separately. Select the Reflector model most suited to the application.



Reflectors *[Refer to Dimensions on page 18.]*

Reflectors required for Retro-reflective Sensors: A Reflector is not provided with the Sensor. Be sure to order a Reflector separately.

Sensor	Sensing distance	Appearance	Model	Quantity	Remarks
E3FA-R□1 E3FB-R□1	0.1 to 4 m		E39-R1S	1	for E3FA-R□, E3RA-R□, E3FB-R□ and E3RB-R□
E3FA-R□2 E3FB-R□2	0 to 500 mm				
E3FA-B□1 E3FB-B□1	100 to 500 mm		E39-RP1	1	for E3FA-B□ and E3FB-B□
E3FA-B□2 E3FB-B□2	0.1 to 2 m				

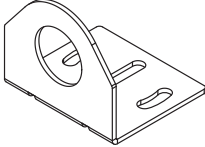

Mounting brackets *[Refer to Dimensions on page 18.]*

A Mounting Bracket is not enclosed with the Sensor. Order a Mounting Bracket separately if required.

Sensor	Appearance	Model (Material)	Quantity	Remarks
all types		E39-L183 (SUS304)	1	Mounting bracket
E3FA-□ E3RA-□		E39-L182 (POM)	1	Flush mounting bracket

Sensor I/O connectors

Models for Connectors: A Connector is not provided with the Sensor. Be sure to order a Connector separately.

Sensor	Size	Cable	Appearance	Cable type	Model
M12 connector types	M12	Standard	Straight 	2 m	XS2F-M12PVC4S2M
				5 m	XS2F-M12PVC4S5M
			Angle 	2 m	XS2F-M12PVC4A2M
				5 m	XS2F-M12PVC4A5M

Model Number Legend

E3□-□□□□-(□)□
1 2 3 4 5 6 7

1. Series name

FA: Cylindrical, Straight type, Plastic housing
 RA: Cylindrical, Radial type, Plastic housing
 FB: Cylindrical, Straight type, Metal housing
 RB: Cylindrical, Radial type, Metal housing

2. Sensing method

T: Through-beam
 R: Retro-reflective with MSR function
 D: Diffuse-reflective
 L: Background suppression
 V: Limited distance reflective
 B: Transparent detected with P-opaqing function

3. Output

P: PNP
 N: NPN

4. Connection

1: Cable
 2: Connector, M12, 4-pin

5. Difference of sensing distance, difference of light source

Sequential number

6. Emitter/Receiver

D: Receiver
 L: Emitter

7. Cable length

Blank: Connector type

e.g., E3FA-TP11 2M;

Cylindrical, Straight type, Plastic housing/ Through-beam/ PNP/
 Cable/ Difference of Sensing distance/ Cable length of 2M

E3RA-TN12-D;

Cylindrical, Radial type, Plastic housing/ Through-beam/ NPN/
 Connector, M12, 4-pin/ Difference of Sensing distance/
 Receiver/ Connector type

E3FA-VP12;

Cylindrical, Straight type, Plastic housing/ Limited distance
 reflective/ PNP/ Connector, M12, 4-pin/ Difference of Sensing
 distance/ Connector type

E3FA/E3RA/E3FB/E3RB

Ratings and Specifications

Straight type (E3FA/E3FB)

Model	Sensing method		Through-beam		Retro-reflective with MSR function	Coaxial Retro-reflective with MSR function
	NPN output	Pre-wired M12 Connector	E3F□-TN11 2M	E3FA-TN12 2M	E3F□-RN11 2M	E3F□-RN12 2M
Item	PNP output	Pre-wired M12 Connector	E3F□-TP11 2M	E3FA-TP12 2M	E3F□-RP11 2M	E3F□-RP12 2M
			E3F□-TP21	E3FA-TP22	E3F□-RP21	E3F□-RP22
Sensing distance			20 m	15 m	0.1 to 4 m (with E39-R1S)	0 to 500 mm (with E39-R1S)
Spot diameter (reference value)			—			
Standard sensing object			Opaque: 7 mm dia.min.		Opaque: 75 mm dia.min.	
Differential travel			—			
Directional angle			2° min.			
Light source (wavelength)			Red LED (624 nm)	Infrared LED (850 nm)	Red LED (624 nm)	
Power supply voltage			10 to 30 VDC (include voltage ripple of 10%(p-p) max.)			
Current consumption			40 mA max. (Emitter 25 mA max. Receiver 15 mA max.)		25 mA max.	
Control output			NPN/PNP (open collector) Load current: 100 mA max. (Residual voltage: 3 V max.), Load power supply voltage: 30 VDC max.			
Operation mode			Light-ON/Dark-ON selectable by wiring			
Indicator			Operation indicator (orange) Stability indicator (green) Power indicator (green): only Emitter of Through-beam			
Protection circuits			Power supply reverse polarity protection, Output short-circuit protection, and Output reverse polarity protection			
Response time			0.5 ms			
Sensitivity adjustment			One-turn adjuster			
Ambient illumination (Receiver side)			Incandescent lamp: 3,000 lx max./ Sunlight: 10,000 lx max.			
Ambient temperature range			Operating: -25 to 55°C/ Storage: -30 to 70°C (with no icing or condensation)			
Ambient humidity range			Operating: 35 to 85%/ Storage: 35 to 95% (with no condensation)			
Insulation resistance			20 MΩ min. at 500 VDC			
Dielectric strength			1,000 VAC at 50/60 Hz for 1 min. between current-carrying parts and case			
Vibration resistance			Destruction: 10 to 55 Hz, 1.5 mm double amplitude for 2 hours each in X, Y and Z directions			
Shock resistance			Destruction: 500 m/s ² 3 times each in X, Y and Z directions			
Degree of protection			IEC: IP67, DIN 40050-9: IP69K *			
Weight (packed state/only sensor)	Pre-wired cable (2M)		E3FA: Approx. 110 g/ Approx. 50 g, respectively, E3FB: Approx. 175 g/ Approx. 65 g, respectively		E3FA: Approx. 60 g/ Approx. 50 g, E3FB: Approx. 95 g/ Approx. 65 g	
	Connector		E3FA: Approx. 30 g/ Approx. 10 g, respectively, E3FB: Approx. 85 g/ Approx. 20 g, respectively		E3FA: Approx. 20 g/ Approx. 10 g, E3FB: Approx. 50 g/ Approx. 20 g	
Material	Case		E3FA: ABS, E3FB: Nickel-brass			
	Lens and Display		PMMA			
	Adjuster		POM			
	Nut		E3FA: POM, E3FB: Nickel-brass			
Accessories			Instruction sheet M18 nuts (4 pcs)		Instruction sheet M18 nuts (2 pcs)	

* IP69K Degree of Protection Specifications

IP69K is a protection specification stipulated by DIN 40050 Part 9 of the German standards.

The test item is sprayed with 80°C water from a nozzle of a specified shape at a water pressure of 80 to 100 bar. The amount of water is 14 to 16 liters per minute.

The distance between the test item and the nozzle is 10 to 15 cm. The water is discharged at angles of 0°, 30°, 60°, and 90° from the horizontal plane for 30 seconds at each angle while the test item is rotated horizontally.

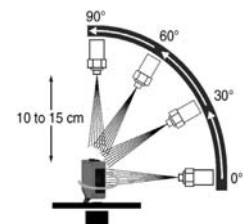

Straight type (E3FA/E3FB)

Model	Sensing method		Diffuse-reflective					
	NPN output	Pre-wired M12 Connector	E3F□-DN11 2M	E3F□-DN12 2M	E3F□-DN13 2M	E3FA-DN14 2M	E3FA-DN15 2M	E3FA-DN16 2M
Item	PNP output	Pre-wired M12 Connector	E3F□-DP11 2M	E3F□-DP12 2M	E3F□-DP13 2M	E3FA-DP14 2M	E3FA-DP15 2M	E3FA-DP16 2M
	Sensing distance			100 mm (white paper: 300 × 300 mm)	300 mm (white paper: 300 × 300 mm)	1 m (white paper: 300 × 300 mm)	100 mm (white paper: 300 × 300 mm)	300 mm (white paper: 300 × 300 mm)
Spot diameter (reference value)			40 × 45 mm Sensing distance of 100 mm	40 × 50 mm Sensing distance of 300 mm	120 × 150 mm Sensing distance of 1 m	40 × 45 mm Sensing distance of 100 mm	40 × 50 mm Sensing distance of 300 mm	120 × 150 mm Sensing distance of 1 m
Standard sensing object			—					
Differential travel			20% max.					
Directional angle			—					
Light source (wavelength)			Red LED (624 nm)			Infrared LED (850 nm)		
Power supply voltage			10 to 30 VDC (include voltage ripple of 10%(p-p) max.)					
Current consumption			25 mA max.					
Control output			NPN/PNP (open collector) Load current: 100 mA max. (Residual voltage: 3 V max.), Load power supply voltage: 30 VDC max.					
Operation mode			Light-ON/Dark-ON selectable by wiring					
Indicator			Operation indicator (orange) Stability indicator (green)					
Protection circuits			Power supply reverse polarity protection, Output short-circuit protection, and Output reverse polarity protection					
Response time			0.5 ms					
Sensitivity adjustment			One-turn adjuster					
Ambient illumination (Receiver side)			Incandescent lamp: 3,000 lx max./ Sunlight: 10,000 lx max.					
Ambient temperature range			Operating: -25 to 55°C/ Storage: -30 to 70°C (with no icing or condensation)					
Ambient humidity range			Operating: 35 to 85%/ Storage: 35 to 95% (with no condensation)					
Insulation resistance			20 MΩ min. at 500 VDC					
Dielectric strength			1,000 VAC at 50/60 Hz for 1 min. between current-carrying parts and case					
Vibration resistance			Destruction: 10 to 55 Hz, 1.5 mm double amplitude for 2 hours each in X, Y and Z directions					
Shock resistance			Destruction: 500 m/s ² 3 times each in X, Y and Z directions					
Degree of protection			IEC: IP67, DIN 40050-9: IP69K *					
Weight (packed state/only sensor)	Pre-wired cable (2M)		E3FA: Approx. 60 g/ Approx. 50 g, E3FB: Approx. 95 g/ Approx. 65 g					
	Connector		E3FA: Approx. 20 g/ Approx. 10 g, E3FB: Approx. 50 g/ Approx. 20 g					
Material	Case		E3FA: ABS, E3FB: Nickel-brass					
	Lens and Display		PMMA					
	Adjuster		POM					
	Nut		E3FA: POM, E3FB: Nickel-brass					
Accessories			Instruction sheet M18 nuts (2 pcs)					

* IP69K Degree of Protection Specifications

IP69K is a protection specification stipulated by DIN 40050 Part 9 of the German standards.

The test item is sprayed with 80°C water from a nozzle of a specified shape at a water pressure of 80 to 100 bar. The amount of water is 14 to 16 liters per minute.

The distance between the test item and the nozzle is 10 to 15 cm. The water is discharged at angles of 0°, 30°, 60°, and 90° from the horizontal plane for 30 seconds at each angle while the test item is rotated horizontally.

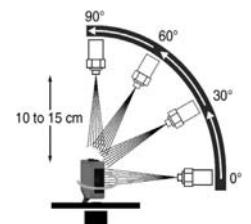

E3FA/E3RA/E3FB/E3RB

Straight type (E3FA/E3FB)

Model	Sensing method		BGS (Background suppression)		Limited distance reflective	Transparent detected with P-opaquiring function	
	NPN output	Pre-wired M12 Connector	E3F□-LN11 2M	E3F□-LN12 2M	E3F□-VN11 2M	E3F□-BN11 2M	E3F□-BN12 2M
Item	PNP output	Pre-wired	E3F□-LP11 2M	E3F□-LP12 2M	E3F□-VP11 2M	E3F□-BP11 2M	E3F□-BP12 2M
		M12 Connector	E3F□-LP21	E3F□-LP22	E3F□-VP21	E3F□-BP21	E3F□-BP22
Sensing distance			100 mm (white paper: 300 × 300 mm)	200 mm (white paper: 300 × 300 mm)	10 to 50 mm (glass(t = 1.0 mm): 150 × 150 mm)	100 to 500 mm (with E39-RP1)	0.1 to 2 m (with E39-RP1)
Spot diameter (reference value)			10 × 10 mm Sensing distance of 100 mm	10 × 15 mm Sensing distance of 200 mm	10 × 10 mm Sensing distance of 50 mm	—	
Standard sensing object			—			glass(t = 1.0 mm): 150 × 150 mm	
Differential travel			20% max.		—		
Directional angle			—				
Light source (wavelength)			Red LED (624 nm)				
Power supply voltage			10 to 30 VDC (include voltage ripple of 10%(p-p) max.)				
Current consumption			25 mA max.				
Control output			NPN/PNP (open collector) Load current: 100 mA max. (Residual voltage: 3 V max.), Load power supply voltage: 30 VDC max.				
Operation mode			Light-ON/Dark-ON selectable by wiring				
Indicator			Operation indicator (orange) Stability indicator (green)				
Protection circuits			Power supply reverse polarity protection, Output short-circuit protection, and Output reverse polarity protection				
Response time			0.5 ms				
Sensitivity adjustment			Fixed		One-turn adjuster		
Ambient illumination (Receiver side)			Incandescent lamp: 3,000 lx max./ Sunlight: 10,000 lx max.				
Ambient temperature range			Operating: -25 to 55°C/ Storage: -30 to 70°C (with no icing or condensation)				
Ambient humidity range			Operating: 35 to 85%/ Storage: 35 to 95% (with no condensation)				
Insulation resistance			20 MΩ min. at 500 VDC				
Dielectric strength			1,000 VAC at 50/60 Hz for 1 min. between current-carrying parts and case				
Vibration resistance			Destruction: 10 to 55 Hz, 1.5 mm double amplitude for 2 hours each in X, Y and Z directions				
Shock resistance			Destruction: 500 m/s ² 3 times each in X, Y and Z directions				
Degree of protection			IEC: IP67, DIN 40050-9: IP69K *				
Weight (packed state/only sensor)	Pre-wired cable (2M)		E3FA: Approx. 60 g/ Approx. 50 g, E3FB: Approx. 95 g/ Approx. 65 g				
	Connector		E3FA: Approx. 20 g/ Approx. 10 g, E3FB: Approx. 50 g/ Approx. 20 g				
Material	Case		E3FA: ABS, E3FB: Nickel-brass				
	Lens and Display		PMMA				
	Adjuster		POM				
	Nut		E3FA: POM, E3FB: Nickel-brass				
Accessories			Instruction sheet M18 nuts (2 pcs)				

* IP69K Degree of Protection Specifications

IP69K is a protection specification stipulated by DIN 40050 Part 9 of the German standards.

The test item is sprayed with 80°C water from a nozzle of a specified shape at a water pressure of 80 to 100 bar. The amount of water is 14 to 16 liters per minute.

The distance between the test item and the nozzle is 10 to 15 cm. The water is discharged at angles of 0°, 30°, 60°, and 90° from the horizontal plane for 30 seconds at each angle while the test item is rotated horizontally.

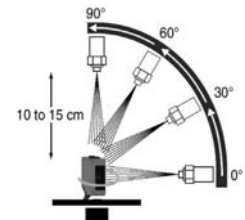

Radial type (E3RA/E3RB)

Model	Sensing method		Through-beam	Retro-reflective with MSR function	Diffuse-reflective		
	NPN output	Pre-wired M12 Connector	E3R□-TN11 2M E3R□-TN21	E3R□-RN11 2M E3R□-RN21	E3R□-DN11 2M E3R□-DN21	E3R□-DN12 2M E3R□-DN22	E3R□-DN13 2M E3R□-DN23
Item	PNP output	Pre-wired M12 Connector	E3R□-TP11 2M E3R□-TP21	E3R□-RP11 2M E3R□-RP21	E3R□-DP11 2M E3R□-DP21	E3R□-DP12 2M E3R□-DP22	E3R□-DP13 2M E3R□-DP23
	Sensing distance			15 m	0.1 to 3 m (with E39-R1S)	100 mm (white paper: 300 × 300 mm)	300 mm (white paper: 300 × 300 mm)
Spot diameter (reference value)			—		35 × 40 mm Sensing distance of 100 mm	40 × 45 mm Sensing distance of 300 mm	90 × 120 mm Sensing distance of 700 mm
Standard sensing object			Opaque: 7 mm dia.min.	Opaque: 75 mm dia.min.	—		
Differential travel			—		20% max.		
Directional angle			2° min.		—		
Light source (wavelength)			Red LED (624 nm)				
Power supply voltage			10 to 30 VDC (include voltage ripple of 10%(p-p) max.)				
Current consumption			40mA max. (Emitter 25 mA max. Receiver 15 mA max.)	25 mA max.			
Control output			NPN/PNP (open collector) Load current: 100 mA max. (Residual voltage: 2 V max.), Load power supply voltage: 30 VDC max.				
Operation mode			Light-ON/Dark-ON selectable by wiring				
Indicator			Operation indicator (orange) Stability indicator (green) Power indicator (green): only Emitter of Through-beam				
Protection circuits			Power supply reverse polarity protection, Output short-circuit protection, and Output reverse polarity protection				
Response time			0.5 ms				
Sensitivity adjustment			One-turn adjuster				
Ambient illumination (Receiver side)			Incandescent lamp: 3,000 lx max./ Sunlight: 10,000 lx max.				
Ambient temperature range			Operating: -25 to 55°C/ Storage: -30 to 70°C (with no icing or condensation)				
Ambient humidity range			Operating: 35 to 85%/ Storage: 35 to 95% (with no condensation)				
Insulation resistance			20 MΩ min. at 500 VDC				
Dielectric strength			1,000 VAC at 50/60 Hz for 1 min. between current-carrying parts and case				
Vibration resistance			Destruction: 10 to 55 Hz, 1.5 mm double amplitude for 2 hours each in X, Y and Z directions				
Shock resistance			Destruction: 500 m/s ² 3 times each in X, Y and Z directions				
Degree of protection			IEC: IP67, DIN 40050-9: IP69K *				
Weight (packed state/only sensor)	Pre-wired cable (2M)		E3RA: Approx. 110 g/ Approx. 50 g, respectively, E3RB: Approx. 175 g/ Approx. 65 g, respectively	E3RA: Approx. 60 g/ Approx. 50 g, E3RB: Approx. 95 g/ Approx. 65 g			
	Connector		E3RA: Approx. 30 g/ Approx. 10 g, respectively, E3RB: Approx. 85 g/ Approx. 20 g, respectively	E3RA: Approx. 20 g/ Approx. 10 g, E3RB: Approx. 50 g/ Approx. 20 g			
Material	Case		E3RA: ABS, E3RB: Nickel-brass				
	Lens and Display		PMMA				
	Adjuster		POM				
	Nut		E3RA: POM, E3RB: Nickel-brass				
Accessories			Instruction sheet M18 nuts (4 pcs)	Instruction sheet M18 nuts (2 pcs)			

* IP69K Degree of Protection Specifications

IP69K is a protection specification stipulated by DIN 40050 Part 9 of the German standards.

The test item is sprayed with 80°C water from a nozzle of a specified shape at a water pressure of 80 to 100 bar. The amount of water is 14 to 16 liters per minute.

The distance between the test item and the nozzle is 10 to 15 cm. The water is discharged at angles of 0°, 30°, 60°, and 90° from the horizontal plane for 30 seconds at each angle while the test item is rotated horizontally.

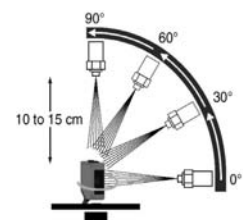

E3FA/E3RA/E3FB/E3RB

Engineering Data (Reference Value)

Parallel Operating Range

Through-beam Models

E3F□-T□, E3R□-T□

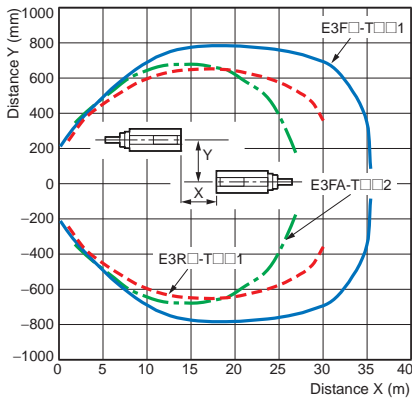

Retro-reflective Models (with MSR function)

E3F□-R□1, E3R□-R□1

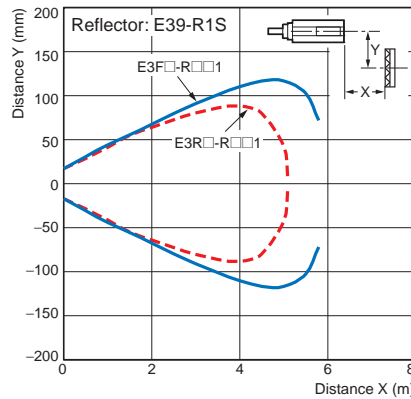

E3F□-R□2

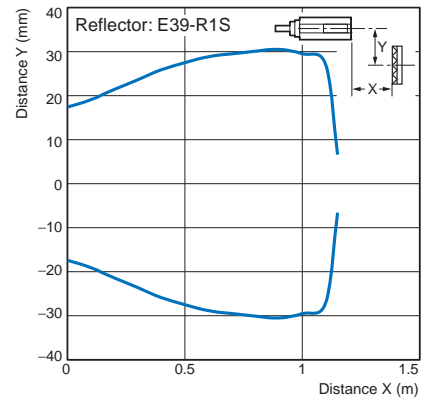

Transparent detected with P-opaqing function

E3F□-B□1

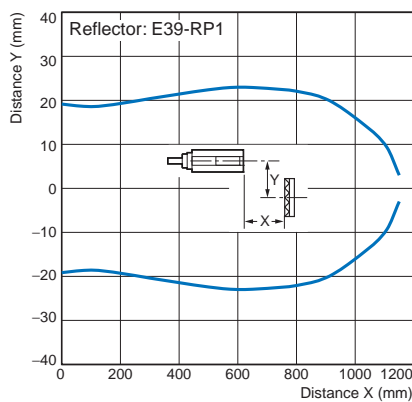

E3F□-B□2

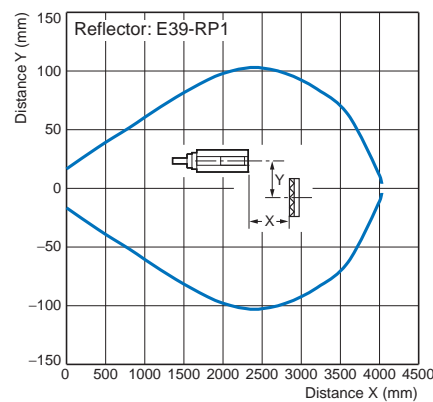

Operating Range

Diffuse-reflective Models

E3F□-D□1, E3F□-D□2
E3R□-D□1, E3R□-D□2

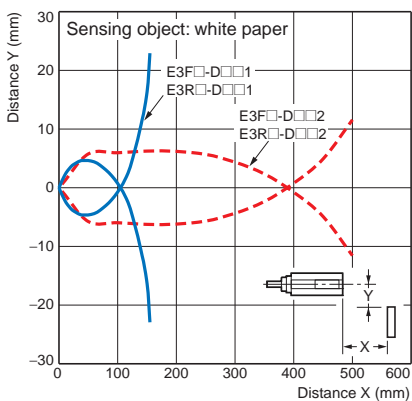

E3F□-D□3, E3R□-D□3

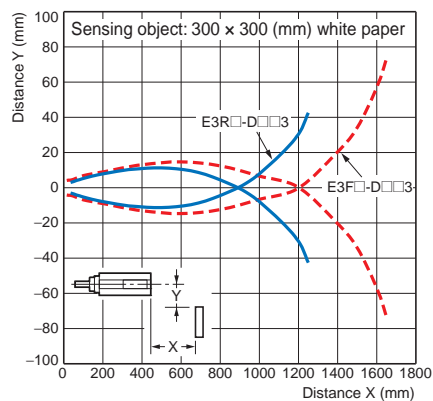

E3FA-D□4, E3FA-D□5

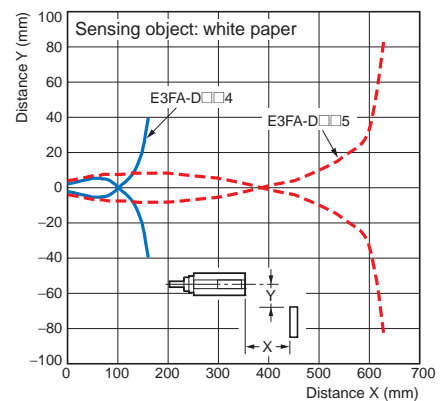

E3FA-D□6

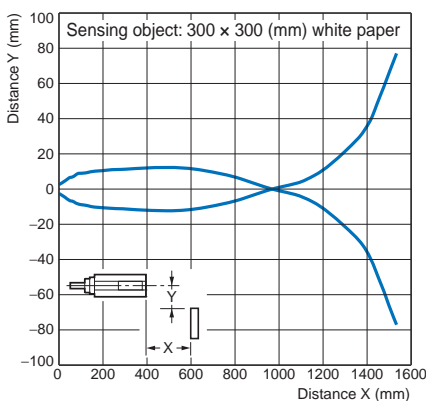

BGS Models

E3F□-L□1, E3F□-L□2

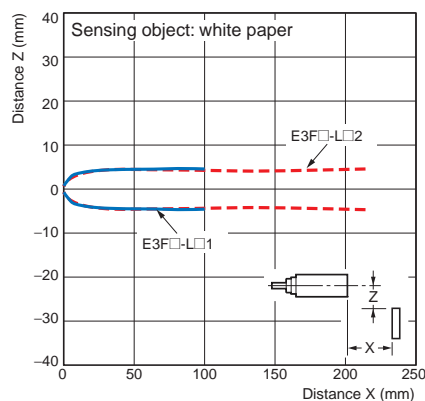

Limited distance reflective

E3F□-V□

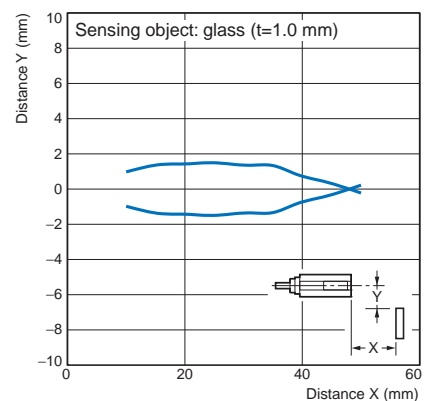

Excess Gain vs. Distance

Through-beam Models

E3F□-T□, E3R□-T□

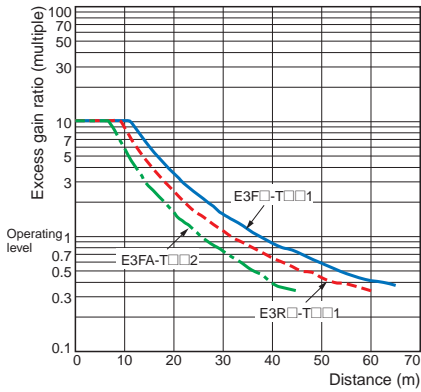

Retro-reflective Models (with MSR function)

E3F□-R□1, E3R□-R□1

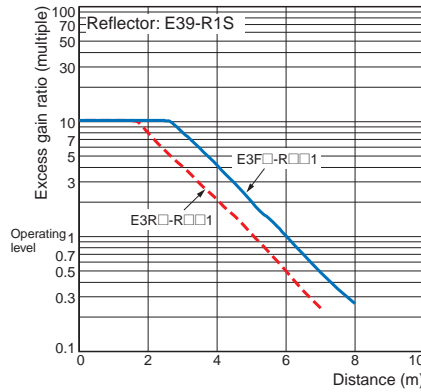

E3F□-R□2

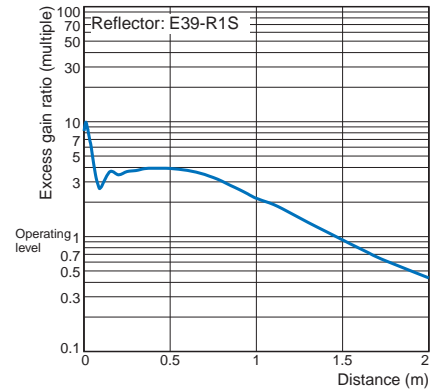

Diffuse-reflective Models

E3F□-D□1, E3F□-D□2

E3R□-D□1, E3R□-D□2

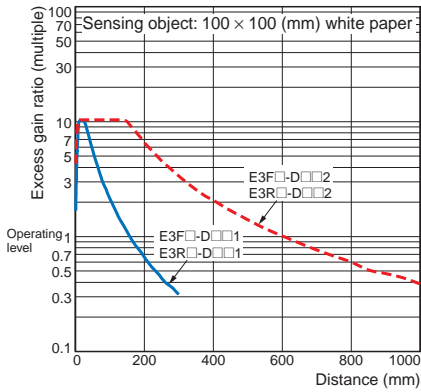

E3F□-D□3, E3R□-D□3

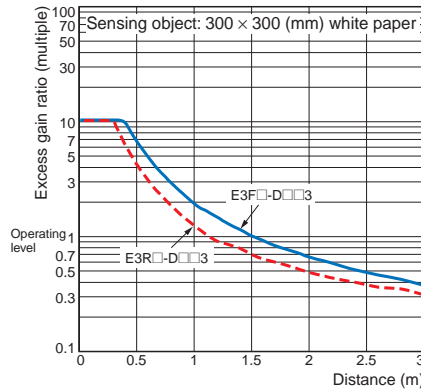

E3FA-D□4, E3FA-D□5

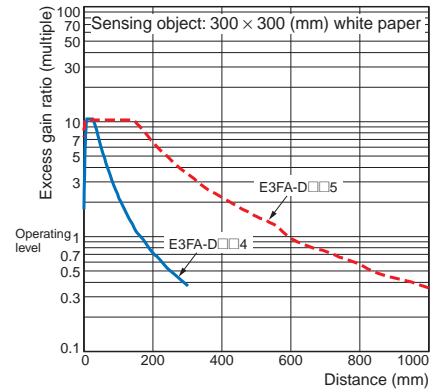

E3FA-D□6

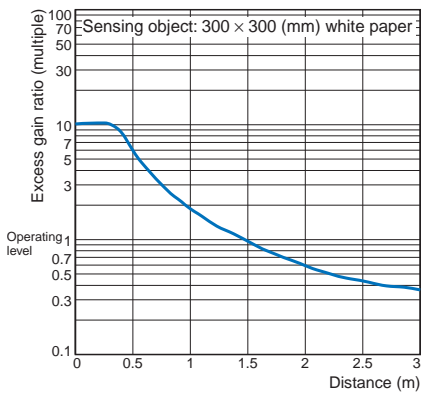

Transparent detected with P-opaquiring function

E3F□-B□1, E3F□-B□2

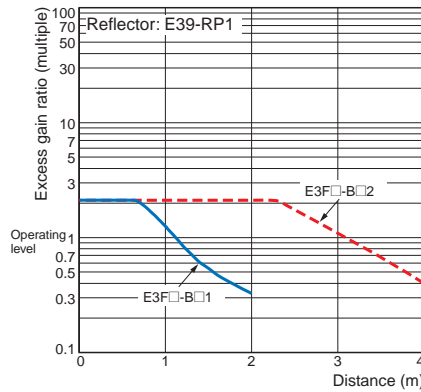

Limited distance reflective

E3F□-V□

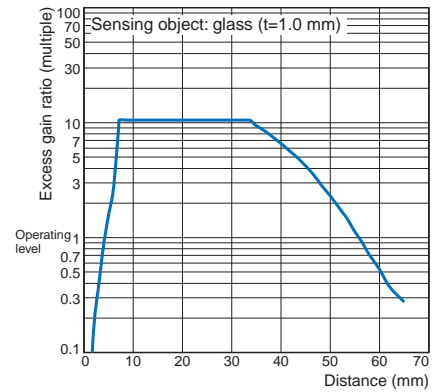

Sensing Object Size vs. Distance

Diffuse-reflective Models

E3F□-D□1, E3F□-D□2

E3R□-D□1, E3R□-D□2

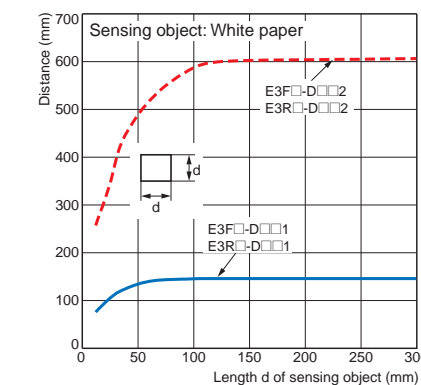

E3F□-D□3, E3R□-D□3

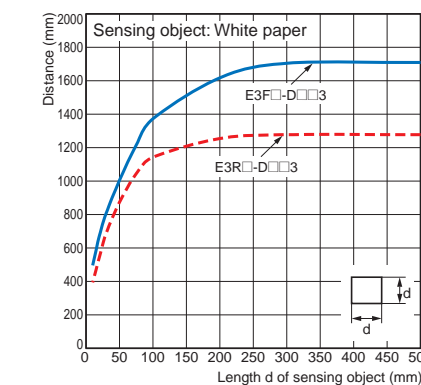

E3FA/E3RA/E3FB/E3RB

E3FA-D□4, E3FA-D□5

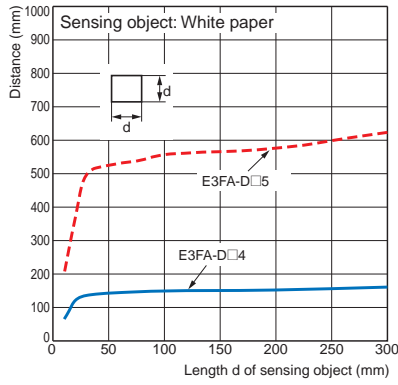

E3FA-D□6

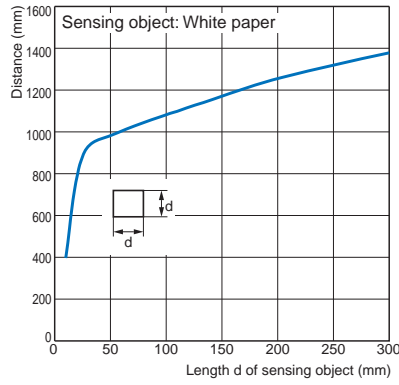

Sensing Distance vs. Sensing Object Material

BGS Models

E3F□-L□1

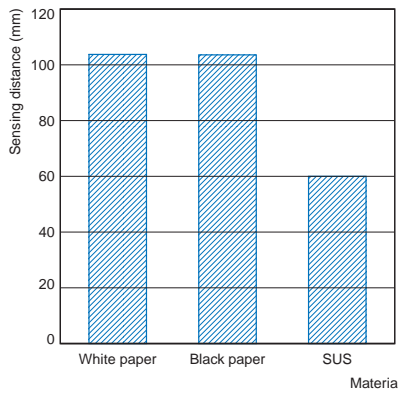

E3F□-L□2

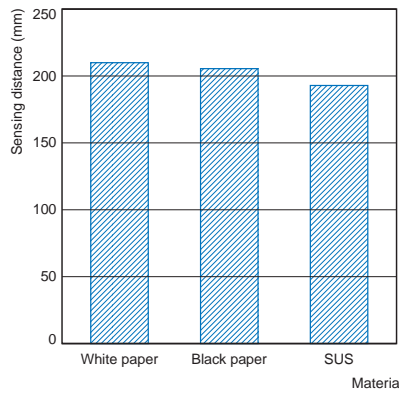

Dark Excess Gain vs. Sensing Object Characteristics

Transparent detected with P-opaqing function

E3F□-B□1

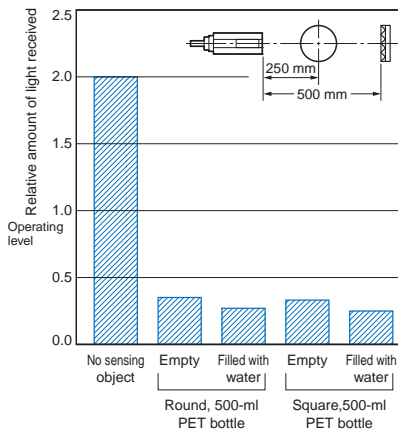

E3F□-B□2

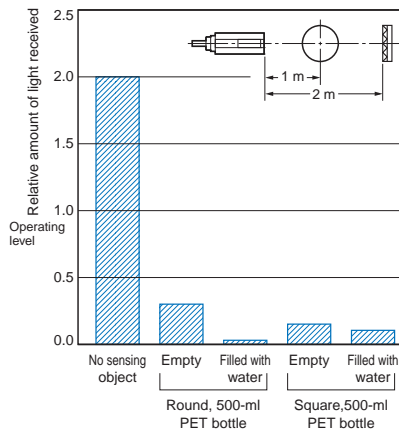

Object Surface Color vs. Sensing Distance

Diffuse-reflective Models

E3FA-D□4

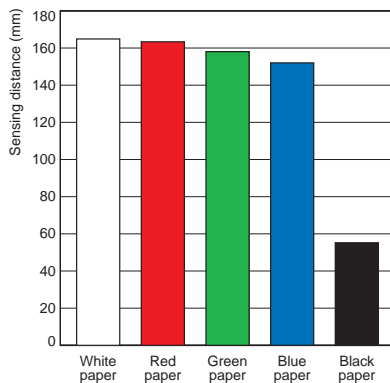

E3FA-D□5

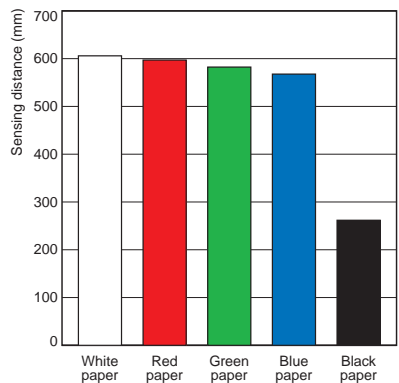

E3FA-D□6

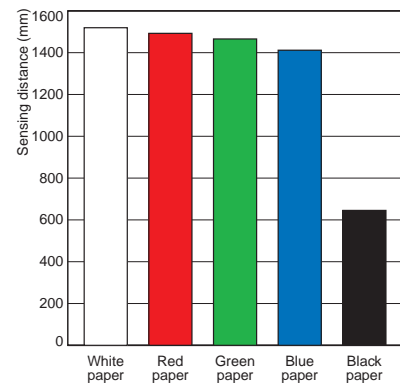

Output circuit diagram

PNP Output

Model	Operation mode	Timing charts	Operation selector	Output circuit
E3F□-TP□ E3F□-RP□ E3F□-DP□ E3F□-VP□ E3F□-BP□ E3R□-TP□ E3R□-RP□ E3R□-DP□	Light-ON		Connect the pink wire (Pin(2)) to the brown (Pin(1))	<p>Through-beam Receivers, Retro-reflective Models, Diffuse-reflective Models, Limited reflective Models. Transparent detected with P-opaqing function.</p>
	Dark-ON		Connect the pink wire (Pin(2)) to the blue (Pin(3)) or open the pink wire (Pin(2))	
<p>Through-beam Emitter</p>				
E3F□-LP□	Light-ON		Connect the pink wire (Pin(2)) to the brown (Pin(1))	<p>Background suppression.</p>
	Dark-ON		Connect the pink wire (Pin(2)) to the blue (Pin(3)) or open the pink wire (Pin(2))	

E3FA/E3RA/E3FB/E3RB

NPN Output

Model	Operation mode	Timing charts	Operation selector	Output circuit
E3F□-TN□ E3F□-RN□ E3F□-DN□ E3F□-VN□ E3F□-BN□ E3R□-TN□ E3R□-RN□ E3R□-DN□	Light-ON		Connect the pink wire (Pin(2)) to the brown (Pin(1)) or open the pink wire (Pin(2))	<p>Through-beam Receivers, Retro-reflective Models, Diffuse-reflective Models, Limited reflective Models. Transparent detected with P-opaqing function.</p>
	Dark-ON		Connect the pink wire (Pin(2)) to the blue (Pin(3))	
<p>Through-beam Emitter</p>				
E3F□-LN□	Light-ON		Connect the pink wire (Pin(2)) to the brown (Pin(1)) or open the pink wire (Pin(2))	<p>Background suppression.</p>
	Dark-ON		Connect the pink wire (Pin(2)) to the blue (Pin(3))	

Connector Pin Arrangement M12 Connector Pin Arrangement



Connectors (Sensor I/O connectors) M12 4-wire Connectors

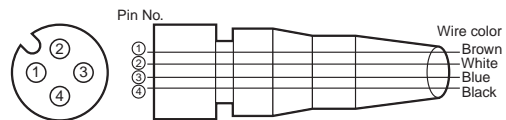

Classification	Wire color	Connector pin No.	Application
DC	Brown	①	Power supply (+V)
	White	②	L/on · D/on selectable
	Blue	③	Power supply (0 V)
	Black	④	Output

Nomenclature

Straight type, Plastic housing

with an adjuster:

E3FA-T□-D

E3FA-R□

E3FA-D□

E3FA-V□

E3FA-B□

without an adjuster:

E3FA-T□-L *

E3FA-L□



* The Emitter has two Power indicators (Green) instead of the Stability indicator (Green) and the Operation indicator (Orange).

Radial type, Plastic housing

with an adjuster:

E3RA-T□-D

E3RA-R□

E3RA-D□

without an adjuster:

E3RA-T□-L *

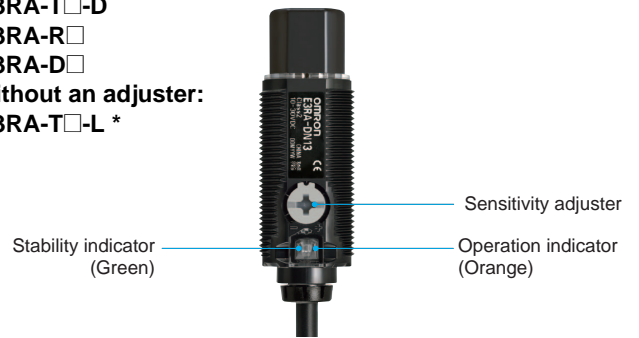

Straight type, Metal housing

with an adjuster:

E3FB-T□-D

E3FB-R□

E3FB-D□

E3FB-V□

E3FB-B□

without an adjuster:

E3FB-T□-L *

E3FB-L□

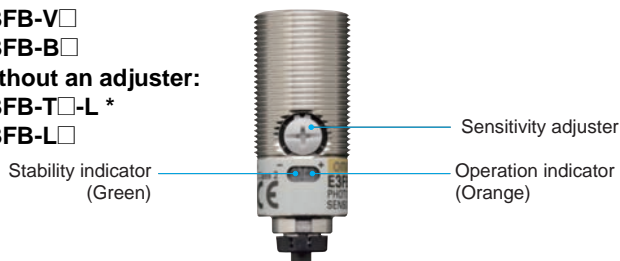

* The Emitter has two Power indicators (Green) instead of the Stability indicator (Green) and the Operation indicator (Orange).

Radial type, Metal housing

with an adjuster:

E3RB-T□-D

E3RB-R□

E3RB-D□

without an adjuster:

E3RB-T□-L *

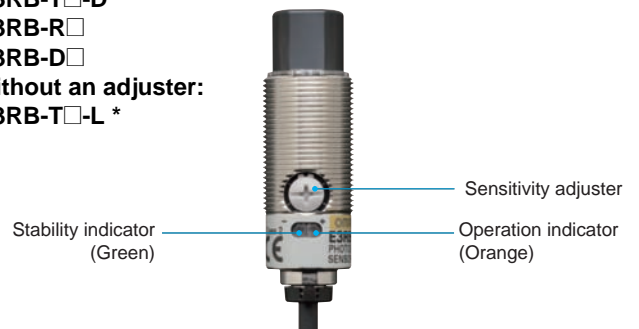

Safety Precautions

Refer to *Warranty and Limitations of Liability*.

WARNING

This product is not designed or rated for directly or indirectly ensuring safety of persons. Do not use it for such a purpose.



CAUTION

Never use the product with an AC power supply. Do not use the product with voltage in excess of the rated voltage.



Do not use the product with incorrect wiring. Otherwise, explosion, fire, malfunction may result.



Precautions for Safe Use

Be sure to follow the safety precautions below for added safety.

1. Do not use the sensor under the environment with explosive, flammable or corrosive gas.
2. Do not use the sensor under the oil or chemical environment.
3. Do not use the sensor in the water, rain or outdoors.
4. Do not use the sensor in the environment where humidity is high and condensation may occur.

5. Do not use the sensor under the environment under the other conditions in excess of rated.
6. Do not use the sensor in place that is exposed by direct sunlight.
7. Do not use the sensor in place where the sensor may receive direct vibration or shock.
8. Do not use the thinner, alcohol, or other organic solvents.
9. Never disassemble, repair nor tamper with the sensor.
10. Please process it as industrial waste.

Precautions for Correct Use

1. Laying Sensor wiring in the same conduit or duct as high-voltage wires or power lines may result in malfunction or damage due to conduit or use shielded cable.
2. Do not pull on the cable with excessive force.
3. If a commercial switching regulator is used, ground the FG (frame ground) terminal.
4. The sensor will be available 100 ms after the power supply is tuned ON. Start to use the sensor 100 ms or more after turning ON the power supply. If the load and the sensor are connected to separate power supplies, be sure to turn ON the sensor first.
5. Output pulses may be generated even when the power supply is OFF. Therefore, it is recommended to first turn OFF the power supply for the load or the load line.
6. The sensor must be mounted using the provided nuts. The proper tightening torque range of E3FA/E3RA plastic housing series is between 0.4 and 0.5 N·m. The proper tightening torque of E3FB/E3RB metal housing series is 20 N·m max..

E3FA/E3RA/E3FB/E3RB

Dimensions

(Unit: mm)
Tolerance class IT16 applies to dimensions in this data sheet unless otherwise specified.

Sensors (E3FA/E3RA Plastic housing)

E3FA series

Pre-wired Models

- E3FA-T□1□
- E3FA-R□1□
- E3FA-D□1□
- E3FA-L□1□
- E3FA-V□11
- E3FA-B□1□

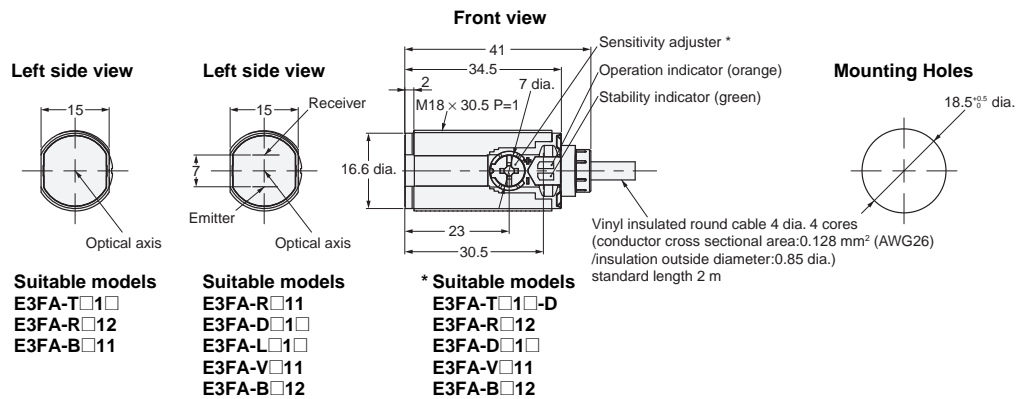

E3FA series

M12 Connector Models

- E3FA-T□2□
- E3FA-R□2□
- E3FA-D□2□
- E3FA-L□2□
- E3FA-V□21
- E3FA-B□2□

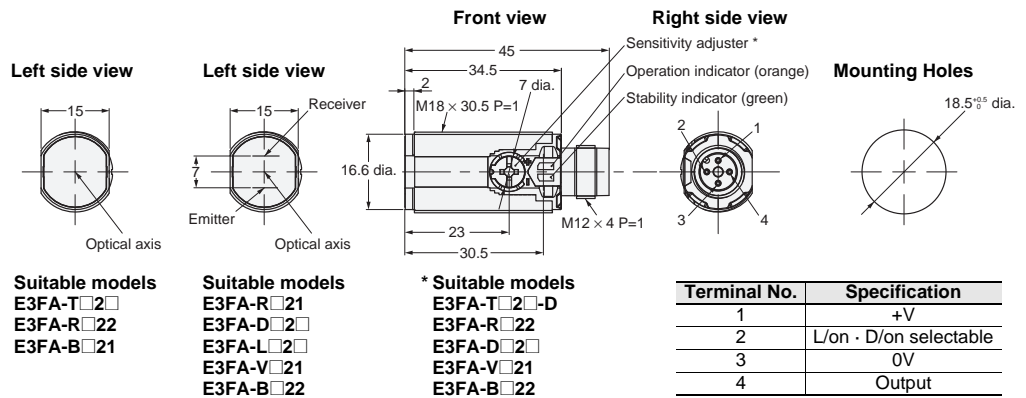

E3RA series

Pre-wired Models

- E3RA-T□11
- E3RA-R□11
- E3RA-D□1□

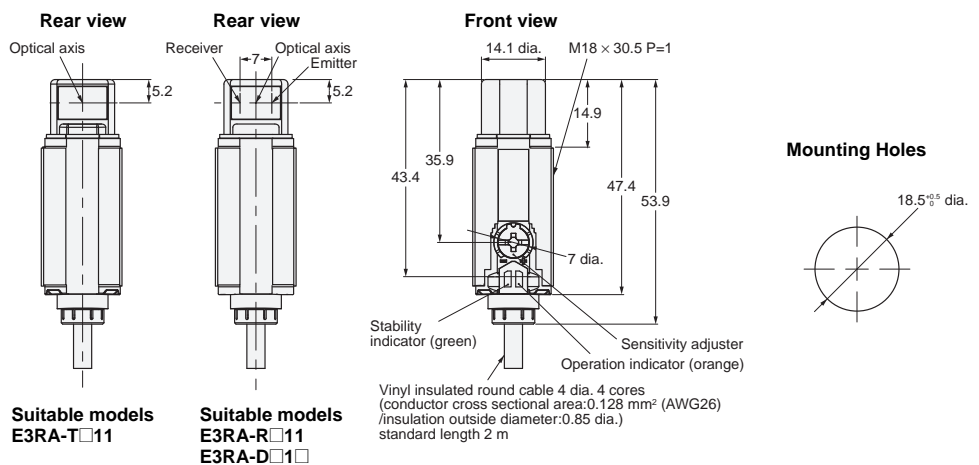

E3RA series

M12 Connector Models

- E3RA-T□21
- E3RA-R□21
- E3RA-D□2□

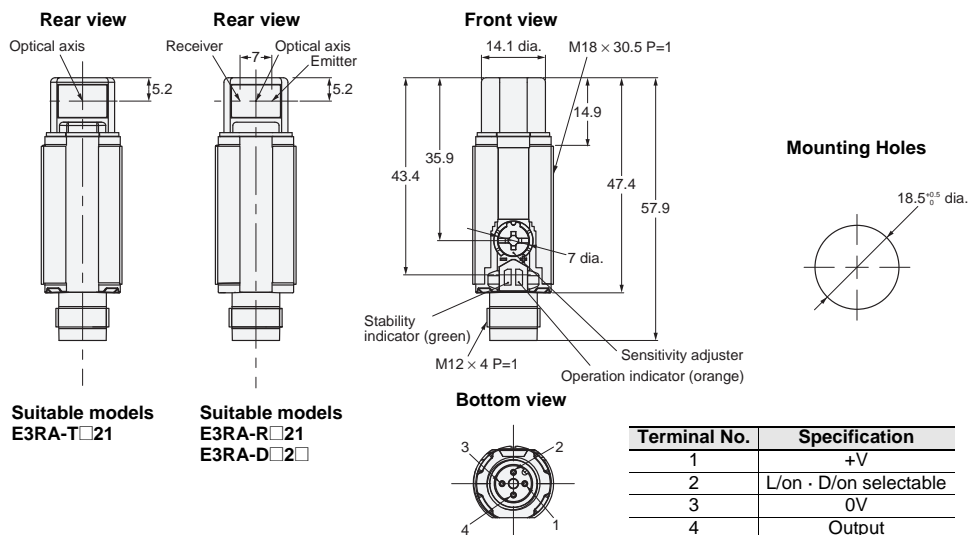

Sensors (E3FB/E3RB Metal housing)

E3FB series

Pre-wired Models

- E3FB-T□11
- E3FB-R□1□
- E3FB-D□1□
- E3FB-L□1□
- E3FB-V□11
- E3FB-B□1□

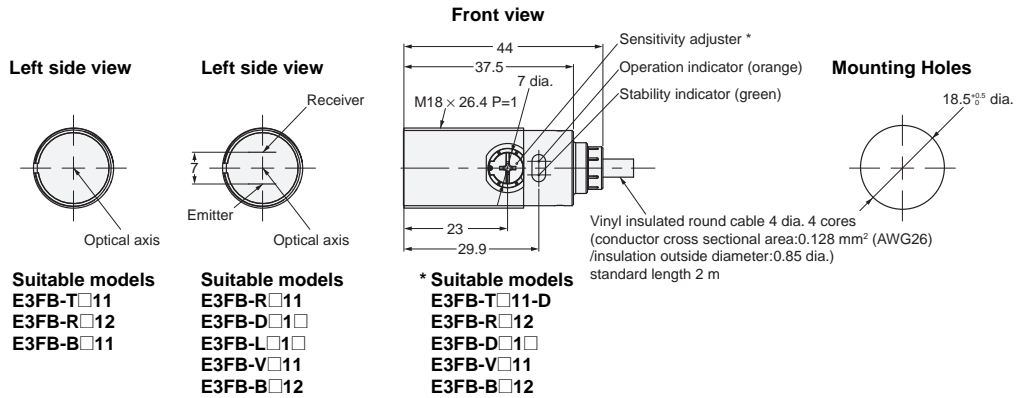

E3FB series

M12 Connector Models

- E3FB-T□21
- E3FB-R□2□
- E3FB-D□2□
- E3FB-L□2□
- E3FB-V□21
- E3FB-B□2□

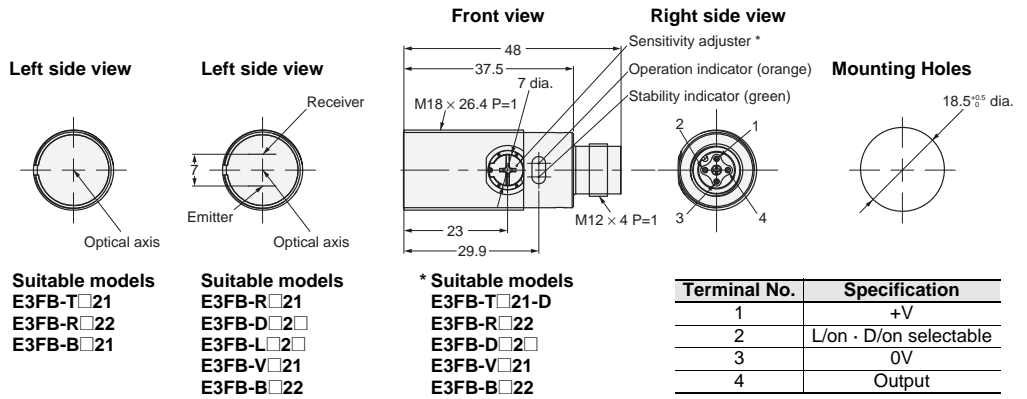

E3RB series

Pre-wired Models

- E3RB-T□11
- E3RB-R□11
- E3RB-D□1□

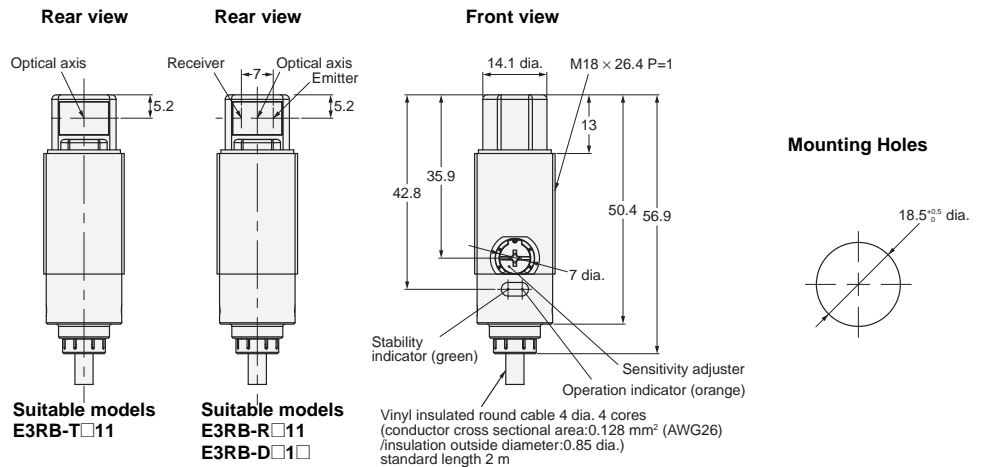

E3RB series

M12 Connector Models

- E3RB-T□21
- E3RB-R□21
- E3RB-D□2□

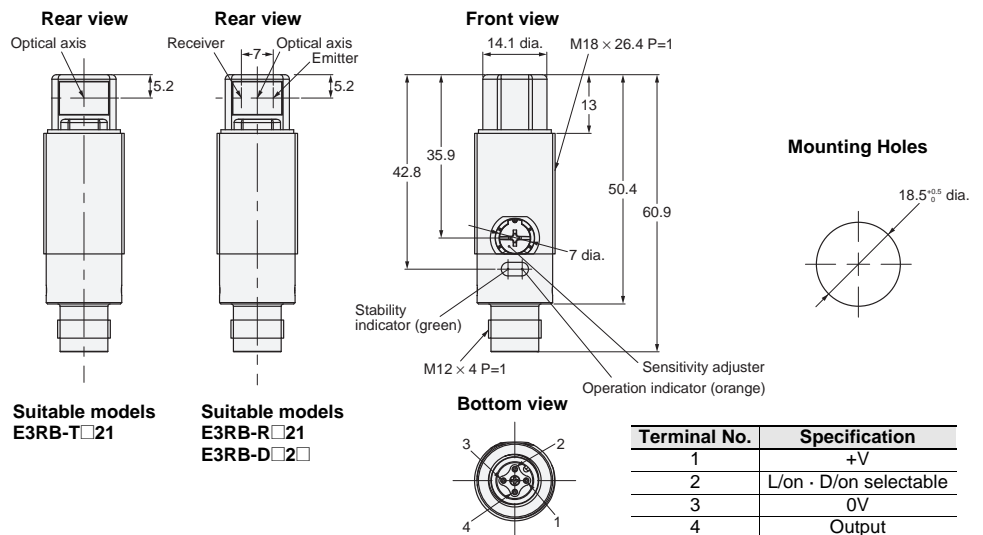

E3FA/E3RA/E3FB/E3RB

Attached nut

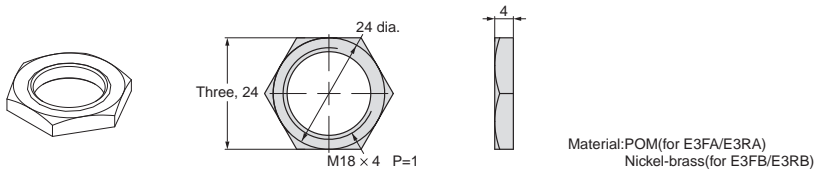

Accessories (Order Separately)

Reflectors

E39-R1S

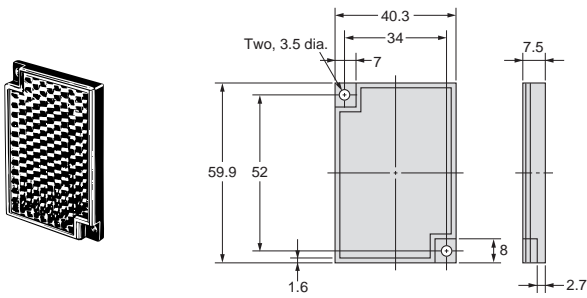

E39-RP1

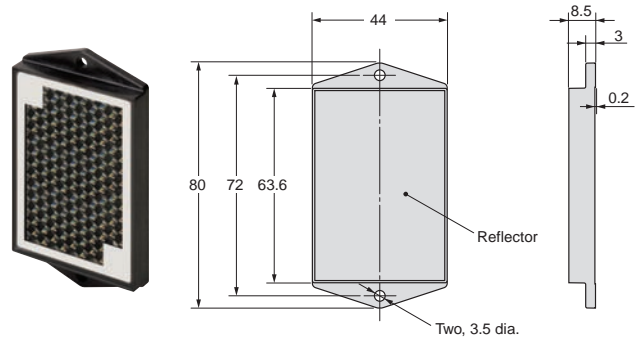

Mounting brackets

E39-L183

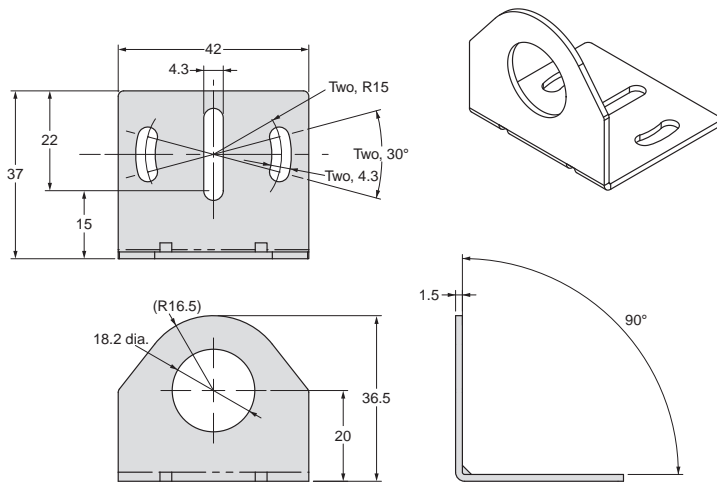

Mounting brackets

E39-L182

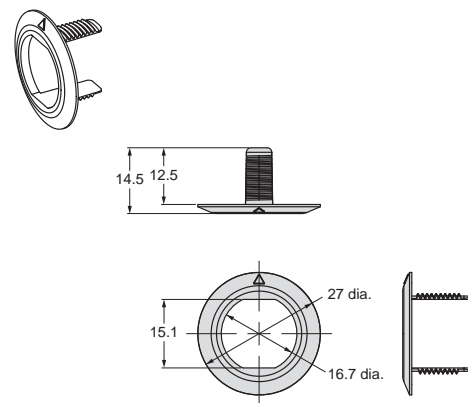

Terms and Conditions Agreement

Read and understand this catalog.

Please read and understand this catalog before purchasing the products. Please consult your OMRON representative if you have any questions or comments.

Warranties.

- (a) Exclusive Warranty. Omron's exclusive warranty is that the Products will be free from defects in materials and workmanship for a period of twelve months from the date of sale by Omron (or such other period expressed in writing by Omron). Omron disclaims all other warranties, express or implied.
- (b) Limitations. OMRON MAKES NO WARRANTY OR REPRESENTATION, EXPRESS OR IMPLIED, ABOUT NON-INFRINGEMENT, MERCHANTABILITY OR FITNESS FOR A PARTICULAR PURPOSE OF THE PRODUCTS. BUYER ACKNOWLEDGES THAT IT ALONE HAS DETERMINED THAT THE PRODUCTS WILL SUITABLY MEET THE REQUIREMENTS OF THEIR INTENDED USE.

Omron further disclaims all warranties and responsibility of any type for claims or expenses based on infringement by the Products or otherwise of any intellectual property right. (c) Buyer Remedy. Omron's sole obligation hereunder shall be, at Omron's election, to (i) replace (in the form originally shipped with Buyer responsible for labor charges for removal or replacement thereof) the non-complying Product, (ii) repair the non-complying Product, or (iii) repay or credit Buyer an amount equal to the purchase price of the non-complying Product; provided that in no event shall Omron be responsible for warranty, repair, indemnity or any other claims or expenses regarding the Products unless Omron's analysis confirms that the Products were properly handled, stored, installed and maintained and not subject to contamination, abuse, misuse or inappropriate modification. Return of any Products by Buyer must be approved in writing by Omron before shipment. Omron Companies shall not be liable for the suitability or unsuitability or the results from the use of Products in combination with any electrical or electronic components, circuits, system assemblies or any other materials or substances or environments. Any advice, recommendations or information given orally or in writing, are not to be construed as an amendment or addition to the above warranty.

See <http://www.omron.com/global/> or contact your Omron representative for published information.

Limitation on Liability; Etc.

OMRON COMPANIES SHALL NOT BE LIABLE FOR SPECIAL, INDIRECT, INCIDENTAL, OR CONSEQUENTIAL DAMAGES, LOSS OF PROFITS OR PRODUCTION OR COMMERCIAL LOSS IN ANY WAY CONNECTED WITH THE PRODUCTS, WHETHER SUCH CLAIM IS BASED IN CONTRACT, WARRANTY, NEGLIGENCE OR STRICT LIABILITY.

Further, in no event shall liability of Omron Companies exceed the individual price of the Product on which liability is asserted.

Suitability of Use.

Omron Companies shall not be responsible for conformity with any standards, codes or regulations which apply to the combination of the Product in the Buyer's application or use of the Product. At Buyer's request, Omron will provide applicable third party certification documents identifying ratings and limitations of use which apply to the Product. This information by itself is not sufficient for a complete determination of the suitability of the Product in combination with the end product, machine, system, or other application or use. Buyer shall be solely responsible for determining appropriateness of the particular Product with respect to Buyer's application, product or system. Buyer shall take application responsibility in all cases.

NEVER USE THE PRODUCT FOR AN APPLICATION INVOLVING SERIOUS RISK TO LIFE OR PROPERTY OR IN LARGE QUANTITIES WITHOUT ENSURING THAT THE SYSTEM AS A WHOLE HAS BEEN DESIGNED TO ADDRESS THE RISKS, AND THAT THE OMRON PRODUCT(S) IS PROPERLY RATED AND INSTALLED FOR THE INTENDED USE WITHIN THE OVERALL EQUIPMENT OR SYSTEM.

Programmable Products.

Omron Companies shall not be responsible for the user's programming of a programmable Product, or any consequence thereof.

Performance Data.

Data presented in Omron Company websites, catalogs and other materials is provided as a guide for the user in determining suitability and does not constitute a warranty. It may represent the result of Omron's test conditions, and the user must correlate it to actual application requirements. Actual performance is subject to the Omron's Warranty and Limitations of Liability.

Change in Specifications.

Product specifications and accessories may be changed at any time based on improvements and other reasons. It is our practice to change part numbers when published ratings or features are changed, or when significant construction changes are made. However, some specifications of the Product may be changed without any notice. When in doubt, special part numbers may be assigned to fix or establish key specifications for your application. Please consult with your Omron's representative at any time to confirm actual specifications of purchased Product.

Errors and Omissions.

Information presented by Omron Companies has been checked and is believed to be accurate; however, no responsibility is assumed for clerical, typographical or proofreading errors or omissions.

ALL DIMENSIONS SHOWN ARE IN MILLIMETERS.

To convert millimeters into inches, multiply by 0.03937. To convert grams into ounces, multiply by 0.03527.

OMRON Corporation Industrial Automation Company
Tokyo, JAPAN

Contact: www.ia.omron.com

Regional Headquarters

OMRON EUROPE B.V.
Sensor Business Unit
Carl-Benz-Str. 4, D-71154 Nufringen, Germany
Tel: (49) 7032-811-0/Fax: (49) 7032-811-199

OMRON ELECTRONICS LLC
One Commerce Drive Schaumburg,
IL 60173-5302 U.S.A.
Tel: (1) 847-843-7900/Fax: (1) 847-843-7787

OMRON ASIA PACIFIC PTE. LTD.
No. 438A Alexandra Road # 05-05/08 (Lobby 2),
Alexandra Technopark,
Singapore 119967
Tel: (65) 6835-3011/Fax: (65) 6835-2711

OMRON (CHINA) CO., LTD.
Room 2211, Bank of China Tower,
200 Yin Cheng Zhong Road,
PuDong New Area, Shanghai, 200120, China
Tel: (86) 21-5037-2222/Fax: (86) 21-5037-2200

Authorized Distributor:

© OMRON Corporation 2012 All Rights Reserved.
In the interest of product improvement,
specifications are subject to change without notice.

CSM_1_7_1013
Cat. No. **E424-E1-03**

Printed in Japan
1013(1112)

Mouser Electronics

Authorized Distributor

Click to View Pricing, Inventory, Delivery & Lifecycle Information:

Omron:

[E3FB-RN22](#) [E3FB-DN21](#) [E3FB-LN22](#) [E3FB-BN22](#) [E3FB-DP13 2M](#) [E3FB-LP11 2M](#) [E3FB-BP11 2M](#) [E3RB-DP13 2M](#) [E3FB-TN11 2M](#) [E3FB-RN11 2M](#) [E3FB-DN11 2M](#) [E3FB-DN22](#) [E3FB-LN11 2M](#) [E3FB-VN11 2M](#) [E3FB-BN11 2M](#) [E3RB-TN11 2M](#) [E3RB-RN11 2M](#) [E3RB-DN11 2M](#) [E3RB-DN22](#) [E3FB-RP11 2M](#) [E3RB-DP21](#) [E3FB-RN21](#) [E3FB-DN13 2M](#) [E3FB-LN21](#) [E3FB-BN21](#) [E3RB-DN13 2M](#) [E3FB-TP11 2M](#) [E3FB-RP21](#) [E3FB-DP11 2M](#) [E3FB-DP22](#) [E3FB-LP21](#) [E3FB-VP11 2M](#) [E3FB-BP21](#) [E3RB-TP11 2M](#) [E3RB-RP11 2M](#) [E3RB-DP11 2M](#) [E3RB-DP22](#) [E3FB-BN12 2M](#) [E3RB-TN21](#) [E3RB-RN21](#) [E3RB-DN12 2M](#) [E3RB-DN23](#) [E3FB-RP12 2M](#) [E3FB-DP21](#) [E3FB-LP12 2M](#) [E3FB-BP12 2M](#) [E3FB-LN12 2M](#) [E3FB-VN21](#) [E3FB-TN21](#) [E3FB-RN12 2M](#) [E3FB-DN12 2M](#) [E3FB-DN23](#) [E3RB-DN21](#) [E3FB-TP21](#) [E3FB-RP22](#) [E3FB-DP12 2M](#) [E3FB-DP23](#) [E3FB-LP22](#) [E3FB-VP21](#) [E3FB-BP22](#) [E3RB-TP21](#) [E3RB-RP21](#) [E3RB-DP12 2M](#) [E3RB-DP23](#)