



**Motor-protective circuit-breaker, 3p, I<sub>r</sub> = 55-65 A, screw connection**

**Part no.** PKZM4-63  
**Article no.** 222413  
**Catalog No.** XTPR063DC1NL

**Delivery programme**

Product range			PKZM4 motor protective circuit-breakers up to 65 A
Basic function			Motor protection
Connection technique			Screw terminals
Contact sequence			

**Max. motor rating**

AC-3			
220 V 230 V 240 V	P	kW	18.5
380 V 400 V 415 V	P	kW	34
440 V	P	kW	37
500 V	P	kW	45
660 V 690 V	P	kW	55

**Setting range**

Overload releases 	I <sub>r</sub>	A	55 - 65
Short-circuit releases 			
max.	I <sub>rm</sub>	A	977

**Notes**

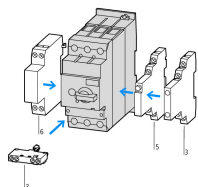

**Accessories**

- 3 Standard auxiliary contact
- 5 Trip-indicating auxiliary contact
- 6 Shunt release, undervoltage release
- Phase failure sensitivity to IEC/EN 60947-4-1, VDE 0660 part 102
- Can be snap-fitted to IEC/EN 60715 top-hat rail with 7.5 or 15 mm height

**Page**

- 072896
- 072898
- 073187
- 266165



PTB 10 ATEX 3012, see manual

**Technical data**

<b>General</b>			
Climatic proofing			Damp heat, constant, to IEC 60068-2-78 Damp heat, cyclic, to IEC 60068-2-30
Ambient temperature			
Storage	θ	°C	-40 - +80
Open		°C	-25 - +55
Enclosed		°C	-25 - +40

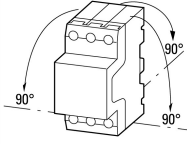
Mounting position			
Direction of incoming supply			as required
Degree of protection			
Device			IP20
Terminations			IP00
Protection against direct contact			Finger and back-of-hand proof
Mechanical shock resistance half-sinusoidal shock 10 ms to IEC 60068-2-27		g	15
Altitude		m	2000
Terminal capacities		mm <sup>2</sup>	
Solid		mm <sup>2</sup>	1 x (1 - 50) 2 x (1 - 35)
Flexible with ferrule		mm <sup>2</sup>	1 x (1 - 35) 2 x (1 - 35)
Solid or stranded		AWG	14 - 2
Specified tightening torque for terminal screws			
Main cable		Nm	3.3
Control circuit cables		Nm	1

### Main conducting paths

Rated impulse withstand voltage	$U_{imp}$	V AC	6000
Overvoltage category/pollution degree			III/3
Rated operational voltage	$U_e$	V AC	690
Rated uninterrupted current = rated operational current	$I_u = I_e$	A	65 open 63 enclosed
Rated uninterrupted current = rated operational current	$I_u = I_e$	A	65
Rated frequency	f	Hz	40 - 60
Current heat loss (3 pole at operating temperature)		W	31.5
Lifespan, mechanical	Operations	$\times 10^6$	0.03
Lifespan, electrical	Operations		30000
Maximum operating frequency		Ops./h	
Max. operating frequency		Ops/h	40
Motor switching capacity		kA <sub>rms</sub>	
DC - 5		V	250/60 kA
DC-5 (up to 250 V)		A	63 (3 contacts in series)

### Trip blocks

Temperature compensation		°C	-5 - +40 (to IEC/EN 60947, VDE 0660) -25 - +55 (operating range)
Temperature compensation residual error for $T > 40^\circ$			$\leq 0.25\%/K$
Setting range of overload releases			$0.6 - 1 \times I_u$
short-circuit release			Basic device, fixed: $15.5 \times I_u$
Short-circuit release tolerance			$\pm 20\%$
Phase-failure sensitivity			IEC/EN 60947-1-1, VDE 0660 Part 102

### Design verification as per IEC/EN 61439

Technical data for design verification			
Rated operational current for specified heat dissipation	$I_n$	A	63
Heat dissipation per pole, current-dependent	$P_{vid}$	W	10.5
Equipment heat dissipation, current-dependent	$P_{vid}$	W	31.5
Static heat dissipation, non-current-dependent	$P_{vs}$	W	0
Heat dissipation capacity	$P_{diss}$	W	0
Operating ambient temperature min.		°C	-25
Operating ambient temperature max.		°C	55
IEC/EN 61439 design verification			

10.2 Strength of materials and parts			
10.2.2 Corrosion resistance			Meets the product standard's requirements.
10.2.3.1 Verification of thermal stability of enclosures			Meets the product standard's requirements.
10.2.3.2 Verification of resistance of insulating materials to normal heat			Meets the product standard's requirements.
10.2.3.3 Verification of resistance of insulating materials to abnormal heat and fire due to internal electric effects			Meets the product standard's requirements.
10.2.4 Resistance to ultra-violet (UV) radiation			Meets the product standard's requirements.
10.2.5 Lifting			Does not apply, since the entire switchgear needs to be evaluated.
10.2.6 Mechanical impact			Does not apply, since the entire switchgear needs to be evaluated.
10.2.7 Inscriptions			Meets the product standard's requirements.
10.3 Degree of protection of ASSEMBLIES			Does not apply, since the entire switchgear needs to be evaluated.
10.4 Clearances and creepage distances			Meets the product standard's requirements.
10.5 Protection against electric shock			Does not apply, since the entire switchgear needs to be evaluated.
10.6 Incorporation of switching devices and components			Does not apply, since the entire switchgear needs to be evaluated.
10.7 Internal electrical circuits and connections			Is the panel builder's responsibility.
10.8 Connections for external conductors			Is the panel builder's responsibility.
10.9 Insulation properties			
10.9.2 Power-frequency electric strength			Is the panel builder's responsibility.
10.9.3 Impulse withstand voltage			Is the panel builder's responsibility.
10.9.4 Testing of enclosures made of insulating material			Is the panel builder's responsibility.
10.10 Temperature rise			The panel builder is responsible for the temperature rise calculation. Eaton will provide heat dissipation data for the devices.
10.11 Short-circuit rating			Is the panel builder's responsibility. The specifications for the switchgear must be observed.
10.12 Electromagnetic compatibility			Is the panel builder's responsibility. The specifications for the switchgear must be observed.
10.13 Mechanical function			The device meets the requirements, provided the information in the instruction leaflet (IL) is observed.

## Technical data ETIM 6.0

Low-voltage industrial components (EG000017) / Motor protection circuit-breaker (EC000074)			
Electric engineering, automation, process control engineering / Low-voltage switch technology / Circuit breaker (LV < 1 kV) / Motor protection circuit-breaker (ecl@ss8.1-27-37-04-01 [AGZ529013])			
Overload release current setting	A		55 - 65
Adjustment range undelayed short-circuit release	A		882 - 882
Thermal protection			No
Phase failure sensitive			Yes
Switch off technique			Thermomagnetic
Rated operating voltage	V		690 - 690
Rated permanent current I <sub>u</sub>	A		65
Rated operation power at AC-3, 230 V	kW		18.5
Rated operation power at AC-3, 400 V	kW		34
Type of electrical connection of main circuit			Screw connection
Type of control element			Turn button
Device construction			Built-in device fixed built-in technique
With integrated auxiliary switch			No
With integrated under voltage release			No
Number of poles			3
Rated short-circuit breaking capacity I <sub>cu</sub> at 400 V, AC	kA		50
Degree of protection (IP)			IP20
Height	mm		140
Width	mm		55
Depth	mm		160

## Approvals

Product Standards			UL 508; CSA-C22.2 No. 14; IEC60947-4-1; CE marking
UL File No.			E36332
UL Category Control No.			NLRV

CSA File No.	165628
CSA Class No.	3211-05
North America Certification	UL listed, CSA certified
Specially designed for North America	No
Suitable for	Branch circuit: Manual type E if used with terminal, or suitable for group installations

## Characteristics

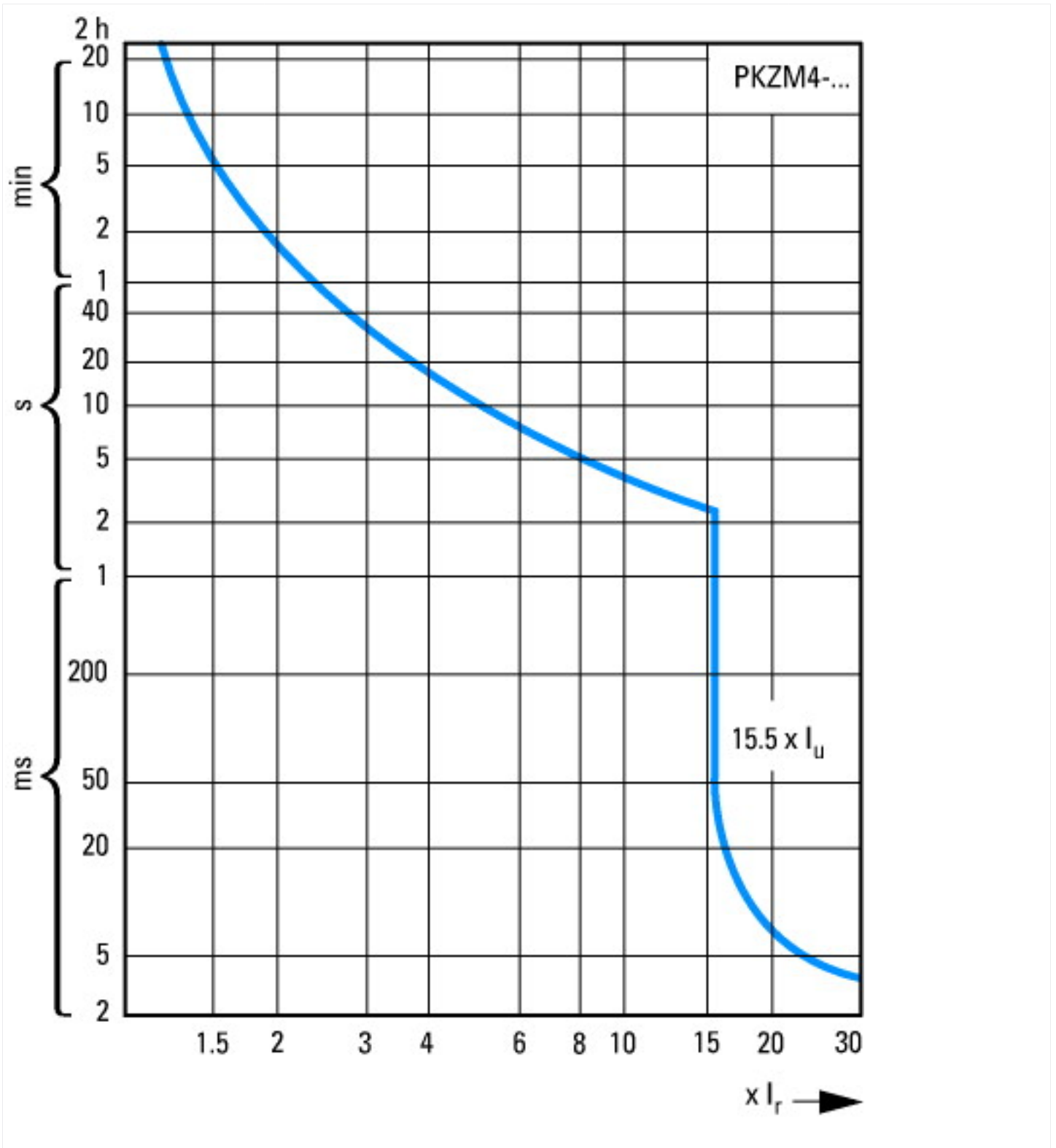

Tripping characteristics

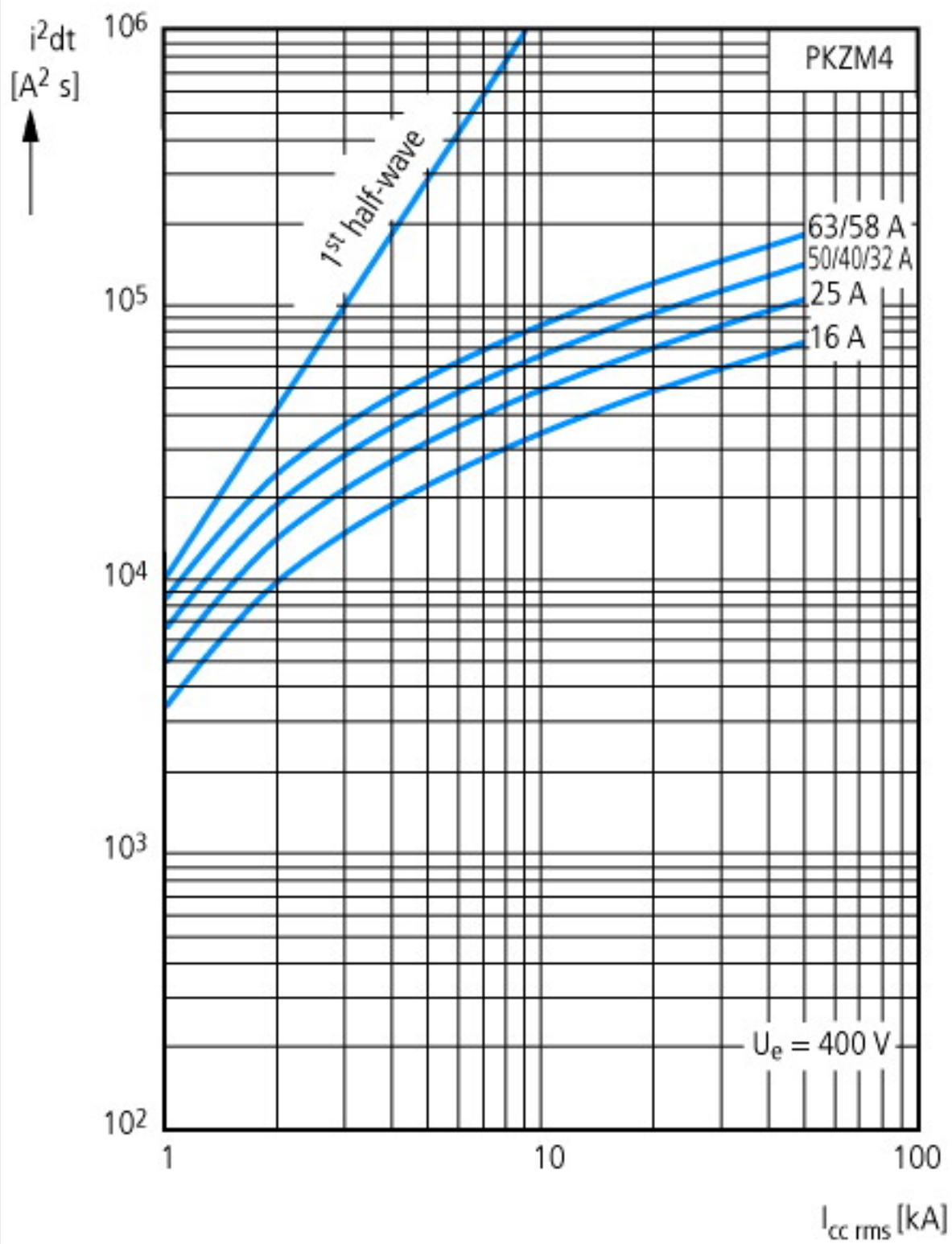

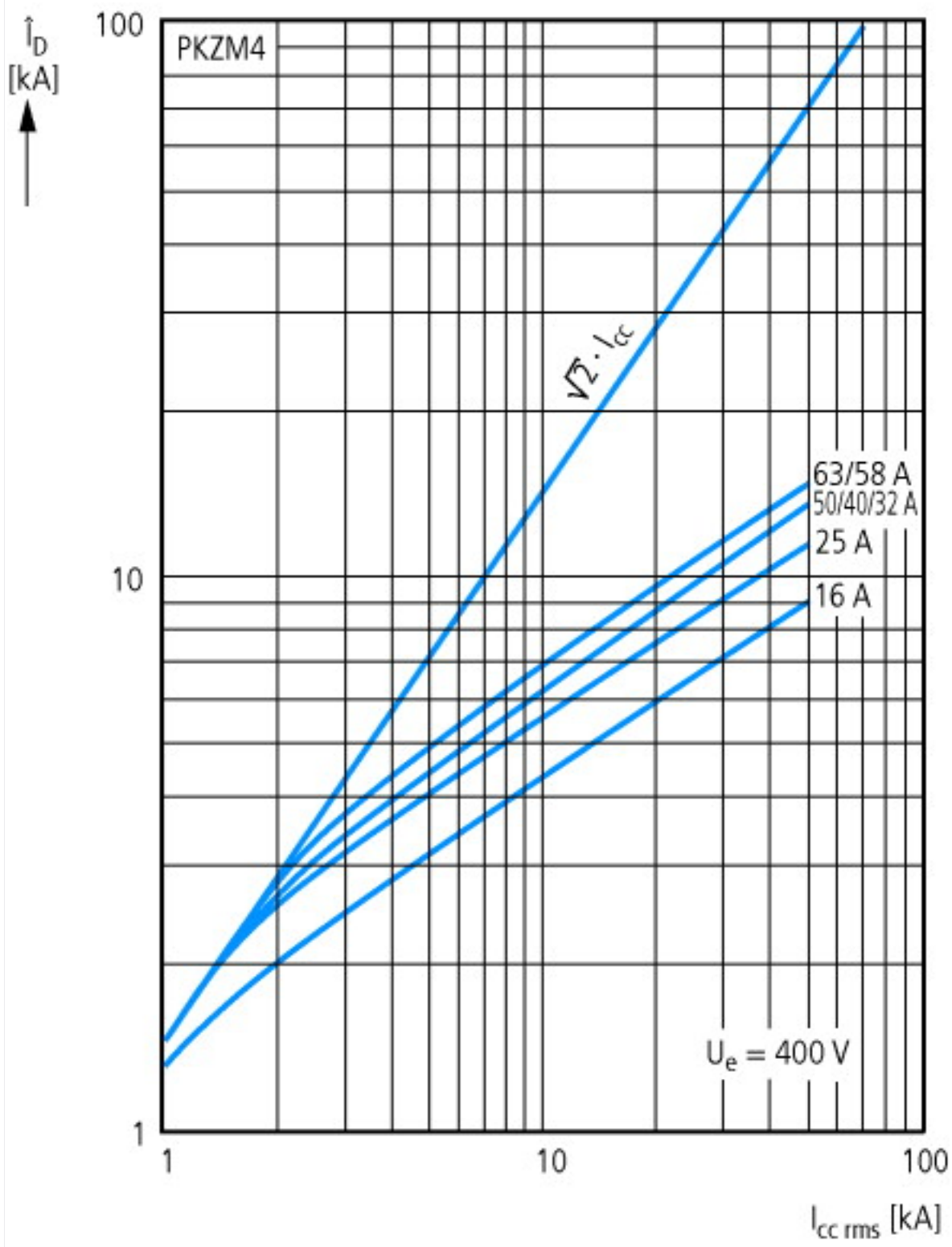

Let-through characteristics

## Dimensions

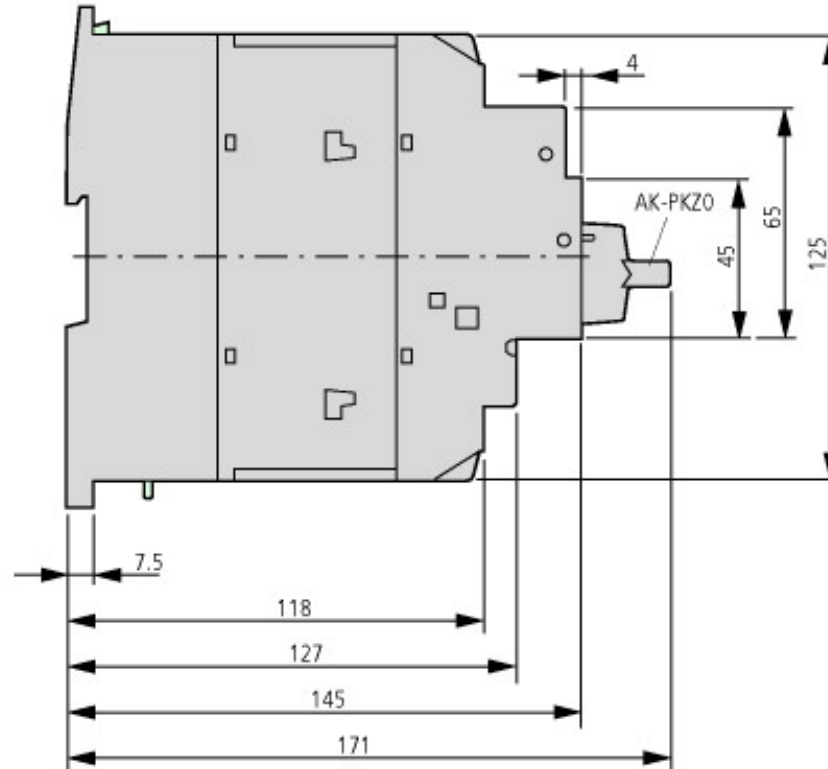
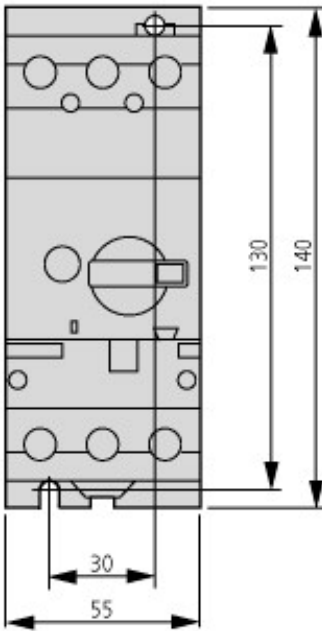
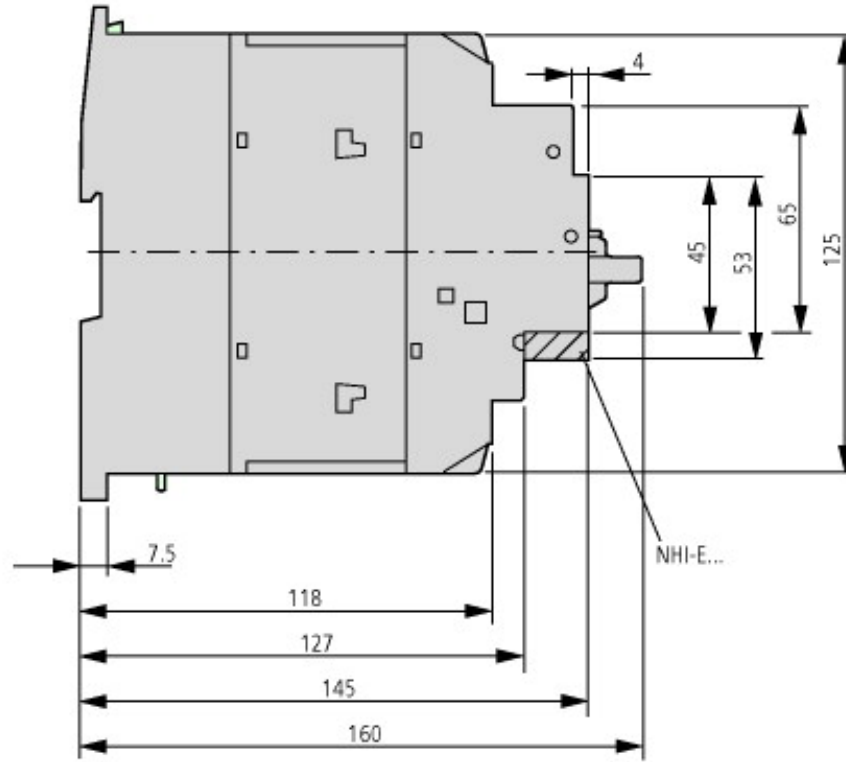
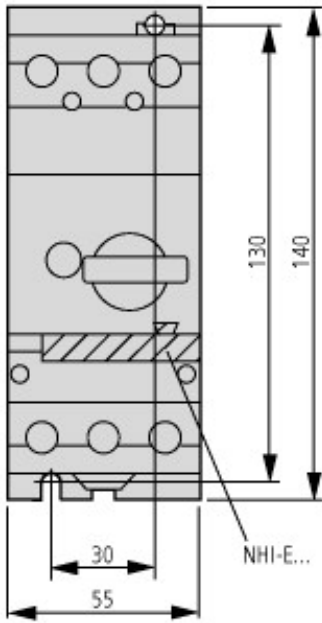

PKZM4-... +AK-PKZO

## Additional product information (links)

### IL03407012Z (AWA1210-1859) Motor-protective circuit-breaker

IL03407012Z (AWA1210-1859) Motor-protective circuit-breaker [ftp://ftp.moeller.net/DOCUMENTATION/AWA\\_INSTRUCTIONS/IL03407012Z2014\\_02.pdf](ftp://ftp.moeller.net/DOCUMENTATION/AWA_INSTRUCTIONS/IL03407012Z2014_02.pdf)

### MN03402002Z (AWB1210-1457) PKZM4 motor-protective circuit-breakers, overload monitoring of Ex e motors

MN03402002Z (AWB1210-1457) PKZM4 motor-protective circuit-breakers, overload monitoring of Ex e motors - Deutsch / English [ftp://ftp.moeller.net/DOCUMENTATION/AWB\\_MANUALS/MN03402002Z\\_DE\\_EN.pdf](ftp://ftp.moeller.net/DOCUMENTATION/AWB_MANUALS/MN03402002Z_DE_EN.pdf)

switching capacity of the circuit-breakers <http://de.ecat.moeller.net/flip-cat/?edition=HPLTEv1&startpage=7.36>

Motor starters and "Special Purpose Ratings" for the North American market [http://www.moeller.net/binary/ver\\_techpapers/ver953en.pdf](http://www.moeller.net/binary/ver_techpapers/ver953en.pdf)

Busbar Component Adapters for modern Industrial control panels [http://www.moeller.net/binary/ver\\_techpapers/ver960en.pdf](http://www.moeller.net/binary/ver_techpapers/ver960en.pdf)

